

CERA

Sanitaryware | Faucets | Tiles

Cera Sanitaryware Limited

Madhusudan House,
Opp. Navrangpura Telephone Exchange,
Navrangpura, Ahmedabad 380006.
Tel: +91 79 26449781, 26449789
Email: marketing@cera-india.com
Web: www.cera-india.com

For customer care

Toll Free: 1800 258 5500
Email: ceracare@cera-india.com
Online: www.cera-india.com/servicerequest



Doc-403D1410/Oct-2018

CERA LOOK BOOK 2018



LOOK BOOK 2018

CERA

Sanitaryware | Faucets | Tiles | Kitchen Sinks | Wellness | Mirrors | Water Heaters

Awards

CERA being an innovative brand has been recognised by the consumers a number of times. These awards range from popular Indian awards like Readers Digest Award to International brand awards like Asia's Most Promising Brand Award.



CERA's new range gives you an experience so unique, you'll lose yourself in a world of your own. A world away from the hustle of daily life. So go ahead, spend quality time with the most important person in your life - yourself.

Certifications and Prestigious Institutional Memberships

Certifications*

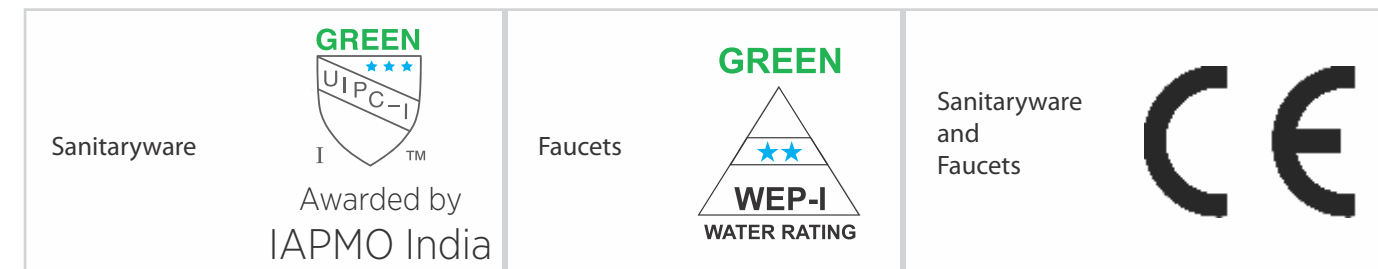

Preferred partner



Membership affiliations



I
N
D
E
X



Sanitaryware
9-56



Faucets
57-156



Kitchen Sinks
157-171



Wellness
172-183



Mirrors
184-193



Water Heaters

Arriving in November 2018

Green Products with star rating

CERA is an organisation that primarily focuses on the conservation of water, one of the most important natural resources. With this objective, CERA has a wide range of water conserving products, built using smart eco-designs and technology. CERA calls this 'ecological sanitation – an idea for a better society.'



COMPACT

EWC Wall Hung P
Cat. No. S1041105
Flushing efficiency 4.2/2.24 LPF*
Water saving 30%



CLAIR

EWC Wall Hung P
Cat. No. S1041109
Flushing efficiency 3.88/2.19 LPF*
Water saving 35%



CRUSE

EWC Wall Hung
Cat. No. S1041111
Flushing efficiency 3.93/2.16 LPF*
Water saving 34%



CARAT

EWC Wall Hung P
Cat. No. S1041101
Flushing efficiency 3.81/2.48 LPF*
Water saving 36%



CAMPBELL CLEAN RIM

EWC Wall Hung P
Cat. No. S1041102
Flushing efficiency 3.90/2.27 LPF*
Water saving 35%



CARNIVAL CLEAN RIM

EWC Wall Hung P
Cat. No. S1041106
Flushing efficiency 3.81/2.48 LPF*
Water saving 36%



CONVENTIONAL

Floor mounting EWC P or S
Cat. No. S1050101
Cat. No. S1050102
Flushing efficiency 5.66/3.27 LPF*
Water saving 6%



UNIVERSAL

Floor mounting EWC P or S
Cat. No. S1050106
Cat. No. S1050107
Flushing efficiency 5.66/3.27 LPF*
Water saving 6%



CARGO

Cat. No. S2040115 Wash Basin
Cat. No. S2090111 Pedestal

CERA

Green Products with star rating



Awarded by
IAPMO India



★★★★

CODI

One Piece EWC S Concealed
Cat. No. S1013101
Flushing efficiency 3.57/2.53 LPF*
Water saving 40%



★★★★

CAMPBELL

One Piece EWC P or S Concealed
Cat. No. S1013109
Cat. No. S1013110
Cat. No. S1013111
Flushing efficiency 3.57/2.53 LPF*
Water saving 40%



★★★★

CLOVER

One Piece EWC P or S Concealed
Cat. No. S1013115
Cat. No. S1013116
Cat. No. S1013117
Flushing efficiency 3.57/2.53 LPF*
Water saving 40%



★★★★

CITRUS

One Piece EWC S Concealed
Cat. No. S1013124
Flushing efficiency 3.57/2.53 LPF*
Water saving 40%



★★★★

CIROCCO

One Piece EWC S Concealed
Cat. No. S1013125
Flushing efficiency 3.53/2.53 LPF*
Water saving 41%



★★★★

CALIBRE

Two Piece EWC S
Cat. No. S1020101
Flushing efficiency 3.88/2.74 LPF*
Water saving 35%



★★★★

CALIBRE DELUXE

Two Piece EWC S Concealed
Cat. No. S1021103
Flushing efficiency 3.98/2.74 LPF*
Water saving 34%



★★★★

CALLAGHAN

Two Piece EWC S Concealed
Cat. No. S1021104
Flushing efficiency 3.96/2.23 LPF*
Water saving 34%



★★★★

CLAIR

Two Piece EWC S
Cat. No. S1020107
Flushing efficiency 3.84/2.19 LPF*
Water saving 36%



★★★★

CAMPBELL

Two Piece EWC S Concealed
Cat. No. S1021109
Flushing efficiency 3.86/2.27 LPF*
Water saving 35%



★★★★

CRUSE

Two Piece EWC S Concealed
Cat. No. S1021113
Flushing efficiency 3.86/2.16 LPF*
Water saving 35%



★★★★

CALIBRE

Two Piece EWC Wall Hung Extended P
Cat. No. S1031101
Flushing efficiency 3.88/2.74 LPF*
Water saving 35%



★★★★

CLAIR

Two Piece EWC Wall Hung Extended P
Cat. No. S1031102
Flushing efficiency 3.88/2.59 LPF*
Water saving 35%



★★★★

CAMPBELL

Two Piece EWC Wall Hung Extended P
Cat. No. S1031103
Flushing efficiency 3.86/2.27 LPF*
Water saving 35%



★★★★

CALLAGHAN

Two Piece EWC Wall Hung Extended P
Cat. No. S1031104
Flushing efficiency 3.87/2.23 LPF*
Water saving 35%



★★★★

CRUSE

Two Piece EWC Wall Hung Extended P
Cat. No. S1031134
Flushing efficiency 3.86/2.16 LPF*
Water saving 35%

Green Products with star rating



CAMPBELL MINI

Wall Hung EWC P
Cat. No. S1041104
Flushing efficiency 3.66/2.27 LPF*
Water saving 39%



CORDO

Wall Hung EWC P
Cat. No. S1041108
Flushing efficiency 3.68/2.19 LPF*
Water saving 38%



CURTIS

Floor mounting EWC S
Cat. No. S1051116
Flushing efficiency 3.98/2.74 LPF*
Water saving 33%



CALCÍA EFS

Urinal Flat Back with integrated EFS
Cat. No. S4010101
Flushing efficiency 0.75 LPF*
Water saving 25%



CICILY EFS

Lidless Sensor Urinal with integrated EFS
Cat. No. S4010102
Flushing efficiency 0.75 LPF*
Water saving 25%

GREEN



PERLA Single lever



F1012101

Pillar cock with aerator
Water saving 41%



F1012151

Bib cock with wall flange and aerator
Water saving 40%



F1012401

Wall mixer with bend pipe for overhead shower
Water saving 40%



F1012451

Single lever basin mixer with 450 mm braided connection pipe (without pop-up)
Water saving 42%



F1012261

Sink cock (wall mounted) with 200 mm (8") long swivel spout and wall flange
Water saving 40%

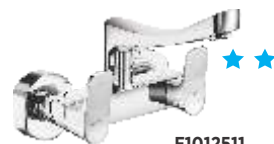

F1012511

Sink mixer (wall mounted) with 200 mm (8") long swivel spout, connecting legs and wall flanges
Water saving 41%



F1012661

Bath tub spout with wall flange
Water saving 42%

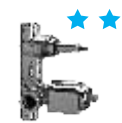

F4010106

Concealed body for turn type single lever concealed diverter system consisting of 35 mm cartridge with button assembly, Cartridge sleeve (but without operating lever, wall flange and tip ton knob)
Concealed part
Water saving 42%

Green Products with star rating

GREEN



VALENTINA Single lever



F1013101

Pillar cock with aerator
Water saving 41%



F1013414

Single lever wall mixer (2-in-1) with provision for telephonic shower arrangement
Water saving 40%



F1013451

Single lever basin mixer with 450 mm braided connection pipe (without pop-up)
Water saving 40%



F1013452

Single lever basin mixer with 305 mm (12") extended body and 450 mm braided connection pipe (without pop-up)
Water saving 42%



F1013551

Single lever sink mixer (table mounted) with 235 mm (9") long swivel spout and 450 mm long braided connection pipe
Water saving 40%



F1013661

Bath tub spout with wall flange
Water saving 42%



F4010107

Concealed body for turn type single lever concealed diverter system consisting of 35 mm cartridge with button assembly, Cartridge sleeve (but without operating lever, wall flange and tip ton knob)
Concealed part
Water saving 42%

GAYLE Single lever



F1014101

Pillar cock with aerator
Water saving 41%



F1014451

Single lever basin mixer with 450 mm braided connection pipe (without pop-up)
Water saving 42%



F1014414

Single lever wall mixer with provision for telephonic shower arrangement
Water saving 42%

Green Products with star rating

DRIVE Quarter turn



F2011101
Pillar cock with aerator
Water saving 42%



F2011461
Single lever basin mixer with
450 mm braided connection pipe
(without pop-up)
Water saving 40%



F2011261
Sink cock (wall mounted)
with 188 mm (7.5")
long swivel spout
and wall flange
Water saving 42%



F2011401
Wall mixer with bend pipe for
overhead shower
Water saving 40%



F2011511
Sink mixer (wall mounted)
with 185 mm (7.5") long
swivel spout, connecting
legs and wall flanges
Water saving 41%



F2011151
Bib cock with wall flange
and aerator
Water saving 40%

CRAYON Quarter turn



F2008101
Pillar cock with aerator
Water saving 41%



F2008461
Central hole basin mixer with
450 mm braided connection
pipe (without pop-up)
Water saving 41%



F2008401
Wall mixer with
210 mm (8.5") max. long bend
pipe for overhead shower
Water saving 41%

Concealed parts

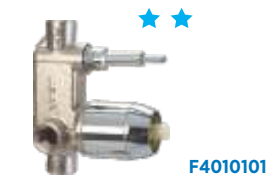

F4010101
Concealed body for single lever
concealed diverter system
consisting of 40 mm cartridge with
button Assembly, Cartridge Sleeve
(but without operating lever,
wall flange and tip ton knob)
Water saving 41%

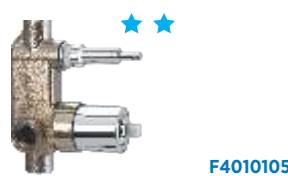

F4010105
Concealed body for turn type single
lever concealed diverter system
consisting of 35 mm cartridge with
button Assembly, Cartridge Sleeve
(but without operating lever,
wall flange and tip ton knob)
Water saving 40%

CERA
Sanitaryware





CERA

ONE PIECE EWCs WITH SEAT COVER AND TWIN FLUSH FITTINGS



CODI
710 x 375 x 660 mm
Cat. No. S1013101 S Trap 220 mm
Cat. No. S1013103 P Trap



CODI
710 x 375 x 660 mm
Cat. No. S1014101 S Trap 220 mm



COPPA
680 x 365 x 670 mm
Cat. No. S1013104 S Trap 220 mm



CLAYTON
660 x 365 x 765 mm
Cat. No. S1013105 S Trap 300 mm



CAPSTAN
715 x 375 x 795 mm
Cat. No. S1013106 S Trap 255 mm
Cat. No. S1013108 P Trap



CAPSTAN
715 x 375 x 795 mm
Cat. No. S1013138 S Trap 255 mm
Cat. No. S1013139 P Trap



CAMPBELL
660 x 350 x 710 mm
Cat. No. S1013109 S Trap 220 mm
Cat. No. S1013110 S Trap 110 mm
Cat. No. S1013111 P Trap



CAPLE
645 x 365 x 705 mm
Cat. No. S1013112 S Trap 285 mm



CRISTY
730 x 365 x 740 mm
Cat. No. S1013113 S Trap 300 mm

ONE PIECE EWCs WITH SEAT COVER AND TWIN FLUSH FITTINGS



CHARISMA

710 x 370 x 745 mm
Cat. No. S1013114 S Trap 100 mm



CLOVER



700 x 370 x 645 mm
Cat. No. S1013115 S Trap 300 mm
Cat. No. S1013116 S Trap 200 mm
Cat. No. S1013117 P Trap



CHRISTINA



705 x 370 x 770 mm
Cat. No. S1013119 S Trap 300 mm



CRUST

625 x 360 x 700 mm
Cat. No. S1013126 S Trap 220 mm



CRUISER



710 x 390 x 790 mm
Cat. No. S1013127 S Trap 300 mm



CRUISER



DUROPLAST SEAT COVER

710 x 390 x 790 mm
Cat. No. S1013137 S Trap 300 mm



CAMAC

740 x 400 x 700 mm
Cat. No. S1013120 S Trap 220 mm



CIMONA



700 x 370 x 760 mm
Cat. No. S1013122 S Trap 300 mm



CLOUD



690 x 380 x 780 mm
Cat. No. S1013123 S Trap 300 mm



CHISEL

675 x 365 x 710 mm
Cat. No. S1013128 S Trap 285 mm
Cat. No. S1013129 S Trap 220 mm



CURATOR

645 x 350 x 730 mm
Cat. No. S1013132 S Trap 250 mm



CARR



DUROPLAST SEAT COVER

700 x 400 x 775 mm
Cat. No. S1013140 S Trap 300 mm



CITRUS



655 x 370 x 730 mm
Cat. No. S1013124 S Trap 220 mm



CITRUS



DUROPLAST SEAT COVER

655 x 370 x 730 mm
Cat. No. S1014124 S Trap 220 mm



CIROCCO



680 x 360 x 700 mm
Cat. No. S1013125 S Trap 200 mm



CAM



DUROPLAST SEAT COVER

690 x 390 x 720 mm
Cat. No. S1013141 S Trap 250 mm



CAT



DUROPLAST SEAT COVER

650 x 360 x 745 mm
Cat. No. S1013142 S Trap 300 mm



CADMUS

DUROPLAST SEAT COVER

705 x 385 x 705 mm
Cat. No. S1013143 S Trap 300 mm

ONE PIECE EWCs WITH SEAT COVER AND TWIN FLUSH FITTINGS



CARTIN
DUROPLAST SEAT COVER

700 x 405 x 755 mm
Cat. No. S1013144 S Trap 300 mm



CLANG
DUROPLAST SEAT COVER

700 x 430 x 770 mm
Cat. No. S1013145 S Trap 300 mm



CORIUM
DUROPLAST SEAT COVER

690 x 380 x 770 mm
Cat. No. S1013146 S Trap 200 mm



CRUSE

710 x 370 x 770 mm
Cat. No. S1012135 S Trap 300 mm
Cat. No. B1520110
Cruse soft close seat cover



CRUSE
BIDET SEAT COVER

710 x 370 x 770 mm
Cat. No. S1012135 S Trap 300 mm
Cat. No. B1540102
Cruse soft close bidet seat cover



NEW
CRUSE
DUROPLAST SEAT COVER

710 x 370 x 770 mm
Cat. No. S1012135 S Trap 300 mm
Cat. No. B1530116
Cruse Duroplast Seat Cover



CALIBRE

660 x 360 x 760 mm
Cat. No. S1012136 S Trap 220 mm
Cat. No. S1012147 P Trap
Cat. No. B1510117
Calibre Premium Seat Cover



CALIBRE
DUROPLAST SEAT COVER

660 x 360 x 760 mm
Cat. No. S1012136 S Trap 220 mm
Cat. No. S1012147 P Trap
Cat. No. B1530101 Calibre
Duroplast Seat Cover



NANO
GLAZE
TECHNOLOGY

CLEAN
RIM

TWO PIECE EWCs WITH SEAT COVER AND TWIN FLUSH FITTINGS



CALIBRE



660 x 365 x 770 mm
Cat. No. S1020101 S Trap 100 mm
Cat. No. S1020102 P Trap
Cat. No. S1060101 Cistern
Cat. No. B1510101 Carina Seat Cover
Cat. No. B1810101 Twin Flush Fittings

Cat. No. B1510104 Calibre Seat Cover

***Combo pack**
Cistern with Twin Flush Fittings
Cat. No. S1062127



**CALIBRE DELUXE
Concealed**



680 x 360 x 765 mm
Cat. No. S1021103 S Trap 230 mm
Cat. No. S1060101 Cistern
Cat. No. B1510101 Carina Seat Cover
Cat. No. B1810101 Twin Flush Fittings

Cat. No. B1510104 Calibre Seat Cover

***Combo pack**
Cistern with Twin Flush Fittings
Cat. No. S1062127



CALLAGHAN



650 x 405 x 770 mm
Cat. No. S1021104 S Trap 220 mm
Cat. No. S1021105 P Trap
Cat. No. S1060104 Cistern
Cat. No. B1510101 Carina Seat Cover
Cat. No. B1810107 Twin Flush Fittings

Cat. No. B1520102 Cintia Soft Close Seat Cover

***Combo pack**
Cistern with Twin Flush Fittings
Cat. No. S1062133



CURTIS



675 x 435 x 735 mm
Cat. No. S1051116 S Trap 220 mm
Cat. No. B1020105 Twin Flush
Plastic Cistern
Cat. No. B1510101 Carina Seat Cover

Cat. No. B1510104 Calibre Seat Cover



**CLAIR DELUXE
Concealed**

680 x 390 x 835 mm
Cat. No. S1021106 S Trap 120 mm
Cat. No. S1060102 Cistern
Cat. No. B1510108 Clair Seat Cover
Cat. No. B1810103 Twin Flush Fittings

Cat. No. B1520108 Clair Soft Close Seat Cover

***Combo pack**
Cistern with Twin Flush Fittings
Cat. No. S1062135



CLAIR



665 x 390 x 810 mm
Cat. No. S1020107 S Trap 70 mm
Cat. No. S1020108 P Trap
Cat. No. S1060102 Cistern
Cat. No. B1510108 Clair Seat Cover
Cat. No. B1810103 Twin Flush Fittings

Cat. No. B1520108 Clair Soft Close Seat Cover

***Combo pack**
Cistern with Twin Flush Fittings
Cat. No. S1062135



CAMPBELL



655 X 370 x 770 mm
Cat. No. S1021109 S Trap 120 mm
Cat. No. S1021110 P Trap
Cat. No. S1060103 Cistern
Cat. No. B1520106 Campbell Soft Close Seat Cover
Cat. No. B1810113 Twin Flush Fittings

***Combo pack**
Cistern with Twin Flush Fittings
Cat. No. S1062131



CANDID

700 x 360 x 765 mm
Cat. No. S1021116 S Trap 230 mm
Cat. No. S1060113 Cistern
Cat. No. B1520106 Campbell Soft Close Seat Cover
Cat. No. B1810107 Twin Flush Fittings

***Combo pack**
Cistern with Twin Flush Fittings
Cat. No. S1062134



CRUSE



710 x 370 x 810 mm
Cat. No. S1021113 S Trap 300 mm
Cat. No. S1021114 P Trap
Cat. No. S1060106 Cistern
Cat. No. B1510110 Cruse Seat Cover
Cat. No. B1810112 Twin Flush Fittings

Cat. No. B1530116 Cruse Duroplast Seat Cover
Cat. No. B1520110 Cruse Soft Close Seat Cover
Cat. No. B1540101 Cadence Hybrid Seat Cover

***Combo pack**
Cistern with Twin Flush Fittings
Cat. No. S1062129



CALVINA

655 x 400 x 760 mm
Cat. No. S1023115 S Trap 90 mm
Cat. No. S1062112 Cistern
Cat. No. B1520132 Soft Close Seat Cover
Twin Flush Fittings

***Combo pack consists of the ceramic cistern including fittings
#Available in select colour only**

CERA

TWO PIECE WALL HUNG EXTENDED EWCs WITH SEAT COVER AND TWIN FLUSH FITTINGS



CALIBRE



655 x 350 x 735 mm
Cat. No. S1031101 P Trap
Cat. No. S1060101 Cistern
Cat. No. B1510101 Carina Seat Cover
Cat. No. B1810102 Twin Flush Fittings

Cat. No. B1510104 Calibre Seat Cover

***Combo pack**
Cistern with Twin Flush Fittings
Cat. No. S1062128



CLAIR



670 x 390 x 760 mm
Cat. No. S1031102 P Trap
Cat. No. S1060102 Cistern
Cat. No. B1510108 Clair Seat Cover
Cat. No. B1810105 Twin Flush Fittings

Cat. No. B1520108 Clair Soft Close Seat Cover

***Combo pack**
Cistern with Twin Flush Fittings
Cat. No. S1062136



CAMPBELL



655 x 365 x 755 mm
Cat. No. S1031103 P Trap
Cat. No. S1060103 Cistern
Cat. No. B1520106 Campbell Soft Close Seat Cover
Cat. No. B1810106 Twin Flush Fittings

***Combo pack**
Cistern with Twin Flush Fittings
Cat. No. S1062132



CALLAGHAN



655 x 405 x 730 mm
Cat. No. S1031104 P Trap
Cat. No. S1060104 Cistern
Cat. No. B1510101 Carina Seat Cover
Cat. No. B1810107 Twin Flush Fittings

Cat. No. B1520102 Cintia Soft Close Seat Cover
Cat. No. B1510102 Carina ISI Seat Cover

***Combo pack**
Cistern with Twin Flush Fittings
Cat. No. S1062133



CRUSE



655 x 365 x 745 mm
Cat. No. S1031134 P Trap
Cat. No. S1060106 Cistern
Cat. No. B1520110 Cruse Soft Close Seat Cover#
Cat. No. B1810115 Twin Flush Fittings

Cat. No. B1510110 Cruse Seat Cover
Cat. No. B1540101 Cadence Hybrid Seat Cover

***Combo pack**
Cistern with Twin Flush Fittings
Cat. No. S1062130



CURTIS



610 x 350 x 710 mm
Cat. No. S1031111 P Trap
Cat. No. B1020105 Twin Flush Plastic Cistern
Cat. No. B1510101 Carina Seat cover

Cat. No. B1520101 Candy Soft Close Seat Cover
Cat. No. B1520102 Cintia Soft Close Seat Cover
Cat. No. B1510104 Calibre Seat Cover

#Available in select colour only *Combo pack consists of the ceramic cistern including fittings



- Better hygiene
- Easy to clean and maintain
- Better flushing efficiency

CAMPBELL WALL HUNG EWCs WITH SEAT COVER



545 x 350 x 370 mm
 *Cat. No. S1041136 P Trap
 Cat. No. B1520106 Campbell
 Soft Close Seat Cover



510 x 350 x 360 mm
 *Cat. No. S1046105 P Trap
 Cat. No. B1520106 Campbell
 Soft Close Seat Cover



510 x 350 x 360 mm
 *Cat. No. S1041137 P Trap
 Cat. No. B1520106 Campbell
 Soft Close Seat Cover

*Campbell wall hung EWCs with NEW rag bolt distance 230 mm

CARNIVAL WALL HUNG EWCs WITH SEAT COVER



510 x 365 x 380 mm
 Cat. No. S1044135 P Trap
 Cat. No. B1530103 Combo
 Duroplast Soft Close Seat Cover



510 x 365 x 380 mm
 Cat. No. S1041106 P Trap
 Cat. No. B1530103 Combo
 Duroplast Soft Close Seat Cover



510 x 365 x 380 mm
 Cat. No. S1041106 P Trap
 Cat. No. B1520101 Candy Soft Close
 Seat Cover#

Cat. No. B1520111 Carnival Soft
 Close Seat Cover

CARAT WALL HUNG EWCs WITH SEAT COVER



500 x 360 x 350 mm
 Cat. No. S1046101 P Trap
 Cat. No. B1510101 Carina Seat Cover

Cat. No. B1520102 Cintia Soft Close
 Seat Cover



500 x 360 x 350 mm
 Cat. No. S1041101 P Trap
 Cat. No. B1510101 Carina Seat Cover

Cat. No. B1520102 Cintia Soft Close
 Seat Cover

#Available in select colour only. Refer page no. 26 for suitable chair brackets and rag bolts.



WALL HUNG EWCs WITH SEAT COVER



CAMEL
DUROPLAST SEAT COVER

555 x 370 x 365 mm
Cat. No. S1043128 P Trap



CRYO with built in jet
DUROPLAST SEAT COVER

525 x 360 x 365 mm
Cat. No. S1041132 P Trap
Cat. No. B1530104 Cryo duroplast soft close seat cover



COMPACT
GREEN DUROPLAST

490 x 350 x 330 mm
Cat. No. S1041105 P Trap
Cat. No. B1510105 Carona Seat Cover
Cat. No. B1520102 Cintia Soft Close Seat Cover



CORDO
GREEN DUROPLAST

535 x 360 x 335 mm
Cat. No. S1041108 P Trap
Cat. No. B1520112 Croft Soft Close Seat Cover



CLAIR
GREEN DUROPLAST

535 x 380 x 400 mm
Cat. No. S1041109 P Trap
Cat. No. B1510108 Clair Seat Cover
Cat. No. B1520108 Clair Soft Close Seat Cover



CHEREE

535 x 375 x 365 mm
Cat. No. S1043110 P Trap



CRUSE
GREEN DUROPLAST

555 x 365 x 330 mm
Cat. No. S1041111 P Trap
Cat. No. B1520110 Cruse Soft Close Seat Cover

Cat. No. B1510110 Cruse Seat Cover#
Cat. No. B1540101 Cadence Hybrid Seat Cover#



CROMA

550 x 365 x 355 mm
Cat. No. S1043113 P Trap



CROMA
DUROPLAST SEAT COVER

550 x 365 x 355 mm
Cat. No. S1044113 P Trap

Available in select colour only. Refer page no. 26 for suitable chair brackets and rag bolts.

WALL HUNG EWCs



COUPE

565 x 365 x 355 mm
Cat. No. S1041112 P Trap
Cat. No. B1520105 Coupe
Soft Close Seat Cover



CAMEO

550 x 365 x 355 mm
Cat. No. S1043114 P Trap



COUNTY

550 x 340 x 385 mm
Cat. No. S1041115 P Trap
Cat. No. B1520116 County
Soft Close Seat Cover



CORBET

615 x 400 x 365 mm
Cat. No. S1043117 P Trap



CATO

540 x 360 x 355 mm
Cat. No. S1043118 P Trap



CHEVY

565 x 350 x 350 mm
Cat. No. S1043119 P Trap



CALICO

565 x 360 x 350 mm
Cat. No. S1043120 P Trap



CLAREMONT

550 x 375 x 360 mm
Cat. No. S1043123 P Trap



CLAREMONT

DUROPLAST
SEAT COVER

550 x 375 x 360 mm
Cat. No. S1043129 P Trap

RAG BOLTS



Rag Bolts for Wall Hung WCs
Cat. No. B2040101 Rag bolts
Cat. No. B2040102 Rag bolts

CI CHAIRS



Cat. No. B2010101 CI Chair Bracket
for Cat. No. S1031101 Calibre WH Ext.
Cat. No. S1031102 Clair WH Ext.
Cat. No. S1041106 Carnival WH
Cat. No. S1041109 Clair WH

Cat. No. B2010104 CI Chair Bracket
for Cat. No. S1031104 Cruise WH Ext.
Cat. No. S1041111 Cruise WH

Cat. No. B2010105 CI Chair Bracket
for Cat. No. S1041136 Campbell WH
Cat. No. S1031103 Campbell WH Ext.
Cat. No. S1031104 Callaghan WH Ext.
Cat. No. S1041112 Coupe WH

Cat. No. B2010103 CI Chair Bracket
for Cat. No. S1041101 Carat WH

ACCESSORIES



GEL GASKET

(EWC Outlet Sealant)
Cat. No. B2030101

BACK TO WALL EWCs



CRYO with conversion bend
and built in jet



DUROPLAST
SEAT COVER

525 x 360 x 420 mm
Cat. No. S1051119 P Trap
Cat. No. B1530104 Cryo
duroplast soft close seat cover



CAMPBELL

570 x 350 x 395 mm
Cat. No. S1051110 S trap 100 mm
Cat. No. B1520106 Campbell
Soft Close Seat Cover
Rubber V-seal Included



CROMIA

550 x 370 x 340 mm
Cat. No. S5020101 Bidet

FLOOR MOUNTING EWCs



CONVENTIONAL with built in jet



520 x 360 x 390 mm
Cat. No. S1056101 S Trap*
Cat. No. B1510119 Carina
Deluxe Seat Cover



CAMELIA Concealed

570 x 390 x 400 mm
Cat. No. S1051103 S Trap
Cat. No. B1510107 Camelia Seat Cover



CONVENTIONAL



520 x 360 x 390 mm
Cat. No. S1050101 S Trap*
Cat. No. S1050102 P Trap*
Cat. No. B1510119 Carina
Deluxe Seat Cover



UNIVERSAL



570 x 460 x 380 mm
Cat. No. S1050106 S Trap*
Cat. No. S1050107 P Trap*
Cat. No. B1510120 Ceranglo
Deluxe Seat Cover



CIGNIA Concealed

555 x 360 x 400 mm
Cat. No. S1051108 S Trap
Cat. No. B1510101 Carina Seat Cover
Cat. No. B1510106 Carina Plus Seat Cover



CADE Concealed

565 x 360 x 395 mm
Cat. No. S1050109 S Trap
Cat. No. B1510101 Carina Seat Cover
Cat. No. B1520102 Cintia Soft Close
Seat Cover

CISTERNS



CIENA PREMIUM

with Anti Bacterial Knob
Cat. No. B1010102



CENTAUR

Pneumatic Cistern
Cat. No. B1010105



CORONA

Cat. No. B1010101*



CABRISA

Cat. No. B1010106



CABRINA

Cat. No. B1010107



COMBIFLUSH

Twin Flush Cistern
Cat. No. B1020101



CORONA

Twin Flush Cistern
Cat. No. B1020102*



CARRIE

Twin Flush Cistern
Cat. No. B1020104



CABS

Twin Flush Cistern with
ABS body (low level)
Cat. No. B1020103

CERAMIC CISTERNS



CONVENTIONAL

Cat. No. S1060105*
Cat. No. B1810108 Fittings*



**CONVENTIONAL
Twin Flush**

Cat. No. S1061106
Cat. No. B1810110 Fittings

CERA

TWIN FLUSH CONCEALED CISTERNS WITH SET

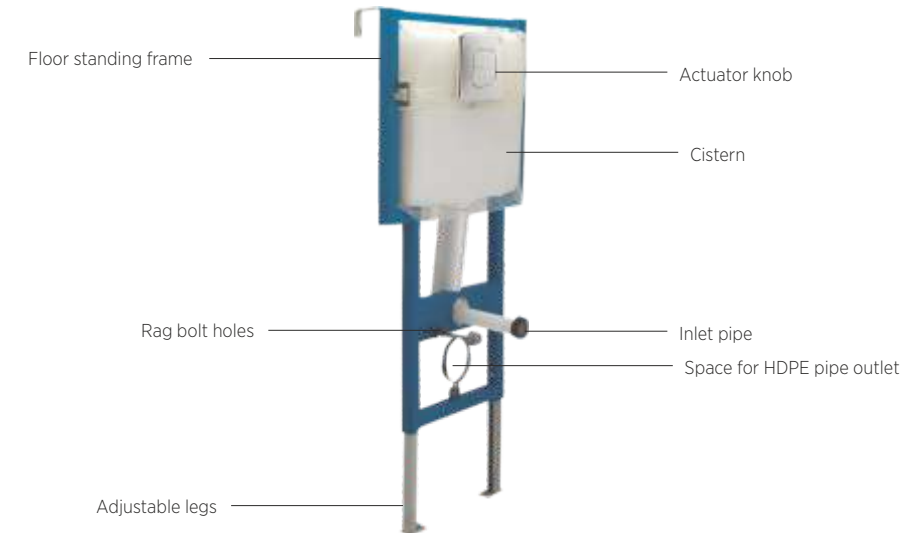

Features:

Easy installation: Easy and hassle free installation as no chiselling of wall is required.

Perfect easy alignment: Inlet and outlet hole for perfect installation of EWC, and pre-defined space for cistern results in perfect flushing every time.

Load bearing capacity: Wall hung EWC can be bolted simply and securely to the frame, which can take a load of up to 400 kg.

Adjustable height: Adjustable legs to allow for variation in heights of EWC, as required

Wide compatibility of EWC: Accommodates different types of wall hung EWCs as holes are provided at different heights

**CERA
SIAMP**

CISTERN WITH FULL FRAME AND HALF FRAME COMPLETE SET (EXCLUDING KNOB)



NEW

CERA SIAMP
Concealed cistern set
with full frame
Cat. No. B1110109
(without knob)

Accessories included in
CERA Siamp cistern with full-frame

Bend discharge pipe 'S' 110 mm
Cat. No. B1190104

Straight discharge pipe
'P' 90 mm Cat. No. B1190105

Adapter sleeve
Cat. No. B1190106

Protection cap cover
Cat. No. B1190107



CERA SIAMP
Concealed cistern set
with half frame
Cat. No. B1110110
(without knob)

Accessories included in
CERA Siamp cistern with half-frame

Straight discharge pipe
'P' 90 mm
Cat. No. B1190105

Adapter sleeve
Cat. No. B1190106

Protection cap cover
Cat. No. B1190107

Actuator Knob options for CERA Siamp cistern

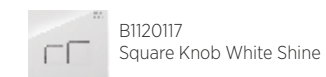

B1120117
Square Knob White Shine



B1120118
Lemon Knob Shine Finish



B1120119
Globe Knob Shine Finish

**CERA
SIAMP**

CISTERN AND ACCESSORIES



CERA SIAMP

550 x 95 x 500 mm
Cat. No. B1110108
(without knob & frame)

Frame options for CERA Siamp Cistern



Full frame
Cat. No. B1130105



Half frame
Cat. No. B1130106

Frame accessories for Siamp Cisterns



Bend discharge pipe 'S' 110 mm
Cat. No. B1190104



Straight discharge pipe 'P' 90 mm
Cat. No. B1190105



Adapter sleeve
Cat. No. B1190106



Protection cap cover
Cat. No. B1190107

Actuator Knob options for CERA Siamp cistern

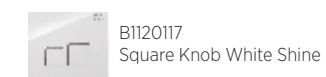

B1120117
Square Knob White Shine



B1120118
Lemon Knob Shine Finish



B1120119
Globe Knob Shine Finish

The above full and half concealed cistern frames are suitable for wall hung EWCs S1041136, S1046105 and S1041137 CAMPBELL, S1041101 CARAT, S1041105 COMPACT, S1041106 CARNIVAL, S1041108 CORDO, S1041109 CLAIR, S1043110 CHEREE, S1041112 COUPE, S1043113 and S1044113 CROMA, S1043114 CAMEO, S1043117 CORBET, S1043118 CATO, S1043123 and S1043129 CLAREMOUNT, S1043120 CALICO, S1043128 CAMEL.

CHEVRON CISTERN WITH FULL FRAME AND HALF FRAME COMPLETE SET (EXCLUDING KNOB)



CHEVRON
Concealed Cistern Set with Full Frame
Cat. No. B1110111
(without knob)

Accessories Included In Chevron Cistern With Full Frame

- Bend discharge pipe 'S' 110 mm
Cat. No. B1190104
- Straight discharge pipe 'P' 90 mm
Cat. No. B1190105
- Adapter sleeve
Cat. No. B1190106
- Protection cap cover
Cat. No. B1190107



CHEVRON
Concealed Cistern Set with Half Frame
Cat. No. B1110112
(without knob)

Accessories included in Chevron cistern with half frame

- Straight discharge pipe 'P' 90 mm
Cat. No. B1190105
- Adapter sleeve
Cat. No. B1190106
- Protection cap cover
Cat. No. B1190107

Actuator Knob options for Chevron cistern

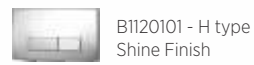

B1120101 - H type
Shine Finish



B1120102 - M type
Shine Finish



B1120104 - Q type
Shine Finish



B1120105 - W type
Shine Finish

CHEVRON CISTERN AND ACCESSORIES



CHEVRON
500 x 90 x 460 mm
Cat. No. B1110101
(without knob & frame)

Frame options for Chevron Cistern



Full frame
Cat. No. B1130101



Half frame
Cat. No. B1130102

Frame accessories for Chevron Cisterns



Bend discharge pipe 'S' 110 mm
Cat. No. B1190104



Straight discharge pipe 'P' 90 mm
Cat. No. B1190105



Adapter sleeve
Cat. No. B1190106



Protection cap cover
Cat. No. B1190107

Actuator Knob options for Chevron cistern

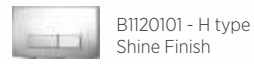

B1120101 - H type
Shine Finish



B1120102 - M type
Shine Finish



B1120104 - Q type
Shine Finish



B1120105 - W type
Shine Finish

OTHER CONCEALED CISTERNS AND ACCESSORIES



CATRINA
495 x 80 x 410 mm
Cat. No. B1110103
(without knob & frame)

Actuator Knob options for Catrina cistern



B1120101 - H type
Shine Finish



B1120102 - M type
Shine Finish



B1120104 - Q type
Shine Finish



B1120105 - W type
Shine Finish



CACHE TOP
415 x 145 x 385 mm
Cat. No. B1110105
(without knob & frame)

Actuator Knob option for Cache Top



B1120115
Chrome Finish

The above full and half concealed cistern frames are suitable for wall hung EWCs S1041136, S1046105 and S1041137 CAMPBELL, S1041101 CARAT, S1041105 COMPACT, S1041106 CARNIVAL, S1041108 CORDO, S1041109 CLAIR, S1043110 CHEREE, S1041112 COUPE, S1043113 and S1044113 CROMA, S1043114 CAMEO, S1043117 CORBET, S1043118 CATO, S1043123 and S1043129 CLAREMOUNT, S1043120 CALICO, S1043128 CAMEL.

COMMON SEAT COVERS FOR EWCS

CERA



CANDY (ANTI MICROBIAL)

Soft Close Seat Cover
Cat No B1520101

Suitable for S1020101, S1020102, S1021104, S1021105, S1031104, S1041101, S1041105, S1050101, S1050102



CINTIA

Soft Close Seat Cover
Cat. No. B1520102

Suitable for EWCs S1041101, S1020101, S1020102, S1031101, S1041105, S1021104, S1021105, S1050109, S1031104, S1021119



CINDY

Soft Close Seat Cover
Cat. No. B1520103

Suitable for EWCs S1050101, S1050102, S1041106, S1041101



CINDY SUPER

Soft Close Seat Cover
Cat. No. B1520104

Suitable for EWCs S1041101



CARINA

Seat Cover
Cat. No. B1510101

Suitable for EWCs S1020101, S1020102, S1050101, S1050102, S1041101, S1031101, S1050109, S1021103, S1021104, S1021105, S1031104



CARINA ISI

Seat Cover
Cat. No. B1510102*

Suitable for EWCs S1020101, S1020102, S1050101, S1050102, S1041101, S1031101, S1050109, S1021103, S1021104, S1021105, S1031104



CARONA

Seat Cover
Cat. No. B1510105

Suitable for EWCs S1041105, S1021104, S1021105, S1031104, S1020101, S1020102, S1031101



CARINA PLUS

Seat Cover
Cat. No. B1510106

Suitable for EWCs S1050101, S1050102, S1041101



CADENCE

Multi-Functional Hybrid Soft Close Seat Cover (non-electronic)
Cat. No. B1540101

Suitable for EWCs S1021113, S1021114, S1041106, S1041111, S1041124



CALIBRE

Seat Cover
Cat. No. B1510104

Suitable for EWCs S1020101, S1020102, S1021103, S1021119, S1021120, S1031101, S1041101, S1041105, S1050101, S1050102, S1051108, S1050104, S1050105



CERANGLO

Seat Cover
Cat. No. B1510103

Suitable for EWC S1050106, S1050107



CARINA DELUXE

Seat Cover
Cat. No. B1510119

Suitable for EWCs S1050101, S1050102, S1056101



CERANGLO DELUXE

Seat Cover
Cat. No. B1510120

Suitable for EWCs S1050106, S1050107



CRUSE

Soft Close Bidet Seat Cover (non-electronic)
Cat. No. B1540102

Suitable for EWC S1012135





*Bottle Trap and Paper Holder not part of the offering.

SPECIAL NEEDS RANGE

CRUSE SET*
 EWC
 710 x 370 x 810 mm
 Cat. No. S1021113 S Trap
 Cat. No. S1021114 P Trap
 Cat. No. S1060106 Cistern
 Cat. No. B1520118 Soft Close Seat Cover
 Cat. No. B1810112 Twin Flush Fittings
 Cat. No. S2040147 Crane Wall Hung Washbasin
 Cat. no. S2090121 Crane Half Pedestal
 Cat. No. F9030451 Clinical Single Lever Basin Mixer
 Cat. No. B2210106 Wall Mounted Grab Bar 600 mm Long
 Cat. No. B2210108 Wall Mounted Hinged Hand Rail 750 x 100

GRAB BARS AND HAND RAILS



U Shaped Rail
 U shaped rail with wall and floor mounting 600 x 100 mm
 Cat. No. B2210101



Hand Rail
 Wall mounted rail (without hinge)
 600 x 100 mm
 Cat. No. B2210102



L Shaped Grab Bar
 Wall mounted inverted 'L' shaped grab bar with 500 and 700 mm long bars
 Cat. No. B2210103



Corner Grab Bar
 Wall mounted corner grab bar with 500 and 600 mm long bars
 Cat. No. B2210104



U Shaped Rail
 Wall mounted rail (with hinge)
 600 x 100 mm
 Cat. No. B2210107



Hand Rail
 Wall mounted Hinged hand rail
 750 x 100 mm
 Cat. No. B2210108



Grab Bar
 Wall mounted grab bar
 350 mm long
 Cat. No. B2210105



Grab Bar
 Wall mounted Grab bar
 600 mm long
 Cat. No. B2210106

SHOWER CHAIRS



Shower Chair (foldable)
 Shower chair with back rest (foldable) 465 x 315 mm
 Cat. No. B2210109



Shower Chair
 440 x 315 mm
 Cat. No. B2210110



CERA

KIDS EWC



CINDERELLA JUNIOR

One Piece EWC with seat cover and fittings
 510 x 295 x 520 mm
 Cat. No. S1013130 S Trap 180 mm

SALON WASH BASIN



CLEANSER

Wash Basin with head rest, tiltable stand, hand shower, hot & cold mixer and waste coupling with strainer
 530 x 610 mm
 Cat. No. S2020110
 Ideal for Beauty Salons
 Ideal for hair and head wash
 Anti-splash keeps floor clean
 Area to store handy material

ONE PIECE WASH BASINS WITH INTEGRATED FULL PEDESTAL



CHEROOKE

520 x 520 x 840 mm
Cat. No. S2010101



CHARLES

500 x 435 x 840 mm
Cat. No. S2010102

ONE PIECE WASH BASINS WITH INTEGRATED HALF PEDESTAL



CLAUS

565 x 460 x 395 mm
Cat. No. S2010103



CISCO

480 x 425 x 365 mm
Cat. No. S2010104



CROFTON

485 x 430 x 385 mm
Cat. No. S2010105

TABLE TOP WASH BASINS



CAMPA

Cat. No. S2020101 450 x 400 mm
Cat. No. S2020102 550 x 400 mm



CAFÉ

600 x 400 mm
Cat. No. S2020103



CORBA

480 x 300 mm
Cat. No. S2020104

TABLE TOP WASH BASINS

CERA



COYAL

460 mm Dia
Cat. No. S2020105



CALA

650 x 420 mm
Cat. No. S2020121



CANAL

370 mm Dia
Cat. No. S2020107



CASTA

445 x 445 mm
Cat. No. S2020134



CALBURT

550 x 400 mm
Cat. No. S2020137



CANCHA

400 x 400 mm
Cat. No. S2020140



CEONA

600 x 400 mm
Cat. No. S2020141

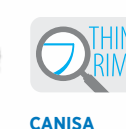

CANISA

405 mm Dia
Cat. No. S2020143



CAHLIN

300 mm dia
Cat. No. S2020148

TABLE TOP WASH BASINS

CERA



350 x 350 mm
Cat. No. S2020149



400 x 360 mm
Cat. No. S2020106



470 x 470 mm
Cat. No. S2020108



600 x 390 mm
Cat. No. S2020122



445 x 445 mm
Cat. No. S2020124



420 mm Dia
Cat. No. S2020125



340 x 300 mm
Cat. No. S2020109



400 mm Dia
Cat. No. S2020112



545 x 400 mm
Cat. No. S2020114



450 mm Dia
Cat. No. S2020127
Installation - Table top and
multilevel recession fixing



595 x 380 mm
Cat. No. S2020126



490 x 310 mm
Cat. No. S2020142



600 x 435 mm
Cat. No. S2020115



445 x 465 mm
Cat. No. S2020116



850 x 535 mm
Cat. No. S2020119



560 x 340 mm
Cat. No. S2020144



480 x 400 mm
Cat. No. S2020145



400 x 300 mm
Cat. No. S2020147



400 x 350 mm
Cat. No. S2020150



CAFÉ DUO

 CAFÉ SILK

 Expressing individual taste

TABLE TOP COLOUR WASH BASINS - CAFÉ DUO

CERA



CAFÉ DUO YELLOW
 600 x 400 mm
 Cat. No. S2021103YL



CAFÉ DUO ORANGE
 600 x 400 mm
 Cat. No. S2021103OR



CAFÉ DUO RED
 600 x 400 mm
 Cat. No. S2021103RD



CAFÉ DUO BLUE
 600 x 400 mm
 Cat. No. S2021103BL

TABLE TOP COLOUR WASH BASINS - CAFÉ SILK

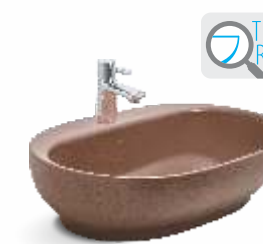

CAFÉ SILK CAPPUCCINO
 600 x 400 mm
 Cat. No. S2022103CC



CAFÉ SILK CARAMEL
 600 x 400 mm
 Cat. No. S2022103CL

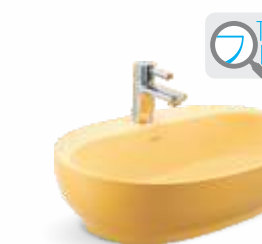

CAFÉ SILK YELLOW
 600 x 400 mm
 Cat. No. S2022103YL



CAFÉ SILK ORANGE
 600 x 400 mm
 Cat. No. S2022103OR



CAFÉ SILK RED
 600 x 400 mm
 Cat. No. S2022103RD



CAFÉ SILK GREY
 600 x 400 mm
 Cat. No. S2022103GY



CAFÉ SILK BLACK
 600 x 400 mm
 Cat. No. S2022103BK



CAFÉ SILK WHITE
 600 x 400 mm
 Cat. No. S2022103WT

SEMI-RECESSED CABINET WASH BASINS



900 x 460 mm
Cat. No. S2030116



Cat. No. S2030121 500 x 420 mm
Cat. No. S2030122 600 x 430 mm



560 x 355 mm
Cat. No. S2030126



510 x 560 mm
Cat. No. S2030131



500 x 420 mm
Cat. No. S2030132

WASH BASINS WITH BUILT-IN COUNTER



700 x 490 mm
Cat. No. S2030107



865 x 500 mm
Cat. No. S2030108
Cat. No. B2020102
Stainless Steel Bracket



550 x 400 mm
Cat. No. S2030109



550 x 400 mm
Cat. No. S2030110

TABLE TOP / WALL HUNG WASH BASINS

CERA



300 x 310 mm
Cat. No. S2020128



600 x 470 mm
Cat. No. S2020129



270 x 340 mm
Cat. No. S2020130



640 x 450 mm
Cat. No. S2020132



515 x 510 mm
Cat. No. S2020133



400 x 380 mm
Cat. No. S2020139

COUNTER WASH BASINS



COUNTER WASH BASINS

CERA



CLAIR

520 x 450 mm
Cat. No. S2030101



OVAL

Cat. No. S2030102 450 x 350 mm
Cat. No. S2030103 560 x 400 mm
Cat. No. S2030104 560 x 470 mm



CAMRY

550 x 405 mm
Cat. No. S2030105



CAMRY MINI

490 x 380 mm
Cat. No. S2030106



CIRCLE

380 mm Dia
Cat. No. S2030113



CONCORD

550 x 425 mm
Cat. No. S2030114



CIRCULAR

470 mm Dia
Cat. No. S2030115



CARMEL

560 x 470 mm
Cat. No. S2030118



CELENE

1000 x 465 mm
with built-in counter
Cat. No. S2030119

COUNTER WASH BASINS



CHESTER

605 x 460 mm
with built-in counter
Cat. No. S2030120



COYOTA

750 x 460 mm
with built-in counter
Cat. No. S2030123



CUSHMAN

1220 x 485 mm
with built-in counter
Cat. No. S2030124 with
wash basin with two bowls



CLIFF

550 x 460 mm
Cat. No. S2030125



CELSO

595 x 405 mm
Cat. No. S2030127



CRESS

905 x 465 mm
Cat. No. S2030129



COMET

570 x 450 mm
Cat. No. S2030136



CABELLA

520 mm dia
Cat. No. S2030138

WALL HUNG WASH BASINS WITH HALF PEDESTAL

CERA



WALL HUNG WASH BASINS WITH HALF PEDESTAL

CERA



COUNSEL

510 x 400 mm
Cat. No. S2040101 Wash basin
Cat. No. S2090102 Half Pedestal
Cat. No. S2090101 Full Pedestal*



COUNSEL

510 x 400 mm
Cat. No. S2040101 Wash basin
Cat. No. S2090103 Half Pedestal
Cat. No. S2090101 Full Pedestal*



CORNET

550 x 400 mm
Cat. No. S2040103 Wash basin*
Cat. No. S2090102 Half Pedestal
Cat. No. S2090101 Full Pedestal*



CONCORD

630 x 450 mm
Cat. No. S2040112 Wash basin
Cat. No. S2090120 Half Pedestal
Cat. No. S2090107 Full Pedestal



CYRESS

670 x 480 mm
Cat. No. S2040130 Wash basin
Cat. No. S2090114 Half Pedestal



CEDAR

620 x 490 mm
Cat. No. S2040131 Wash basin
Cat. No. S2090115 Half Pedestal



CORNET

550 x 400 mm
Cat. No. S2040103 Wash basin*
Cat. No. S2090103 Half Pedestal
Cat. No. S2090101 Full Pedestal*



CORNET

630 x 450 mm
Cat. No. S2040104 Wash basin*
Cat. No. S2090102 Half Pedestal
Cat. No. S2090101 Full Pedestal*



CORNET

630 x 450 mm
Cat. No. S2040104 Wash basin*
Cat. No. S2090103 Half Pedestal
Cat. No. S2090101 Full Pedestal*



CLEMENT

400 x 360 mm
Cat. No. S2040135 Wash basin
Cat. No. S2090119 Ceramic Stand



CHINO

510 x 410 mm
Cat. No. S2040136 Wash basin
Cat. No. S2090104 Half Pedestal



CAILA

650 x 515 mm
Cat. No. S2040151 Wash basin
Cat. No. S2090126 Half Pedestal
Cat. No. S2090122 Full Pedestal



CLAIR

550 x 400 mm
Cat. No. S2040105 Wash basin*
Cat. No. S2090102 Half Pedestal
Cat. No. S2090101 Full Pedestal*



CLAIR

550 x 400 mm
Cat. No. S2040105 Wash basin*
Cat. No. S2090103 Half Pedestal
Cat. No. S2090101 Full Pedestal*



COGNAC

560 x 430 mm
Cat. No. S2040108 Wash basin
Cat. No. S2090102 Half Pedestal
Cat. No. S2090101 Full Pedestal*



CAMMY

510 x 405 mm
Cat. No. S2040148 Wash basin
Cat. No. S2090127 Half Pedestal



CHIME

460 x 350 mm
Cat. No. S2040139
Cat. No. S2090128 Chime Half Pedestal



COGNAC

560 x 430 mm
Cat. No. S2040108 Wash basin
Cat. No. S2090103 Half Pedestal
Cat. No. S2090101 Full Pedestal*



CALIBRE

580 x 430 mm
Cat. No. S2040109 Wash basin
Cat. No. S2090102 Half Pedestal
Cat. No. S2090101 Full Pedestal*



CALIBRE

580 x 430 mm
Cat. No. S2040109 Wash basin
Cat. No. S2090103 Half Pedestal
Cat. No. S2090101 Full Pedestal*

WALL HUNG WASH BASINS WITH FULL PEDESTAL

CERA



COUNSEL

510 x 400 mm
Cat. No. S2040101 Wash basin
Cat. No. S2090101 Pedestal*

Cat. No. S2090102 Half Pedestal
Cat. No. S2090103 Half Pedestal



CORNET

550 x 400 mm
Cat. No. S2040103 Wash basin*
Cat. No. S2090101 Pedestal*

Cat. No. S2090102 Half Pedestal
Cat. No. S2090103 Half Pedestal



CORNET

630 x 450 mm
Cat. No. S2040104 Wash basin*
Cat. No. S2090101 Pedestal*

Cat. No. S2090102 Half Pedestal
Cat. No. S2090103 Half Pedestal



CELESTE

580 x 440 mm
Cat. No. S2040113 Wash basin
Cat. No. S2090106 Pedestal



CANOPY

665 x 495 mm
Cat. No. S2040114 Wash basin
Cat. No. S2090108 Pedestal



CARGO

50 x 480 mm
Cat. No. S2040115 Wash basin
Cat. No. S2090111 Pedestal



CLAIR

550 x 400 mm
Cat. No. S2040105 Wash basin*
Cat. No. S2090101 Pedestal*

Cat. No. S2090102 Half Pedestal
Cat. No. S2090103 Half Pedestal



COGNAC

560 x 430 mm
Cat. No. S2040108 Wash basin
Cat. No. S2090101 Pedestal*

Cat. No. S2090102 Half Pedestal
Cat. No. S2090103 Half Pedestal



CALIBRE

580 x 430 mm
Cat. No. S2040109 Wash basin
Cat. No. S2090101 Pedestal*

Cat. No. S2090102 Half Pedestal
Cat. No. S2090103 Half Pedestal



CALVINA

560 x 475 mm
Cat. No. S2040116 Wash basin
Cat. No. S2090107 Pedestal



CANA

550 x 400 mm
Cat. No. S2040119 Wash basin*
Cat. No. S2090112 Pedestal*



CADAL

515 x 410 mm
Cat. No. S2040120 Wash basin
Cat. No. S2090113 Pedestal



CROWNE

550 x 400 mm
Cat. No. S2040110 Wash basin
Cat. No. S2090105 Pedestal



CRUSE

630 x 510 mm
Cat. No. S2040111 Wash basin
Cat. No. S2090107 Pedestal



CONCORD

630 x 450 mm
Cat. No. S2040112 Wash basin
Cat. No. S2090107 Pedestal

Cat. No. S2090120 Half Pedestal



CANTON

615 x 510 mm
Cat. No. S2040122 Wash basin
Cat. No. S2090107 Pedestal



CANAH

550 x 400 mm
Cat. No. S2040141 Wash basin*
Cat. No. S2090112 Pedestal*



CAILA

650 x 515 mm
Cat. No. S2040151 Wash Basin
Cat. No. S2090122 Full Pedestal

Cat. No. S2090126 Half Pedestal

WALL HUNG WASH BASINS WITH FULL PEDESTAL



CAPE

550 x 470 mm
Cat. No. S2040152 Wash Basin
Cat. No. S2090123 Full Pedestal



CHIA

565 x 430 mm
Cat. No. S2040153 Wash Basin
Cat. No. S2090124 Full Pedestal



CAMBER

605 x 500 mm
Cat. No. S2040154 Wash Basin
Cat. No. S2090125 Full Pedestal

WALL HUNG WASH BASINS WITHOUT PEDESTAL



CANON

450 x 350 mm
Cat. No. S2040102



CALVIN

400 x 355 mm
Cat. No. S2040106



CADAL

515 x 410 mm
Cat. No. S2040121



CORNER

400 x 400 mm
Cat. No. S2040123*



COSY

450 x 300 mm
Cat. No. S2040124*



CALLIS

555 x 420 mm
Cat. No. S2040125



CHICO

465 x 370 mm
Cat. No. S2040126



CLOTIN
(Left)

420 x 280 mm
Cat. No. S2040149
(Bowl on left)



CLOTIN
(Right)

420 x 280 mm
Cat. No. S2040150
(Bowl on right)

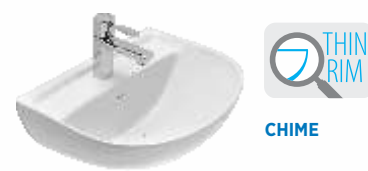

CHIME

460 x 350 mm
Cat. No. S2040139

CERA

COMMON PEDESTALS



CLEA

Cat. No. S2090102 Half pedestal
Suitable for S2040101, S2040103,
S2040104, S2040105, S2040107,
S2040108, S2040109



CLIO

Cat. No. S2090103 Half pedestal
Suitable for S2040101, S2040103,
S2040104, S2040105, S2040107,
S2040108, S2040109



CRUX

Cat. No. S2090101* Full pedestal
Suitable for S2040101, S2040103,
S2040104, S2040105, S2040107,
S2040108, S2040109

RAG BOLTS



RAG BOLTS

for Wall Hung Wash Basin
Cat. No. B2040104

ACCESSORIES



Polyamide braided
connection pipe

12 mm dia, 450 mm
length (2 Piece set)
Cat. No. F8070402



Waste coupling with
ceramic pop-up

push type (full thread) 32 mm
Cat. No. F8050351

URINALS WITH INTEGRATED EFS



CALCIA EFS



360 x 330 x 740 mm
Cat. No. S4010101



CICILY
Lidless Urinal



320 x 300 x 525 mm
Cat. No. S4010102

URINALS



CASEY

315 x 265 x 440 mm
Cat. No. S4020101*



CARMINA

420 x 395 x 635 mm
Cat. No. S4020102*



CAPRIANA

375 x 390 x 590 mm
Cat. No. S4020112*

URINALS



CHRYS

340 x 280 x 470 mm
Cat. No. S4020103



CARYS

325 x 310 x 420 mm
Cat. No. S4020104



CARAVAN

265 x 335 x 695 mm
Cat. No. S4020105



CALCIA

365 x 335 x 670 mm
Cat. No. S4020107



CARTA

450 x 350 x 100 mm
Cat. No. S4040101



CORVIN

90 x 320 x 720 mm
Cat. No. S4090101

ELECTRONIC FLUSHING SYSTEMS



Cat. No. B2050101



Cat. No. B2050104

ACCESSORIES



Channel for Urinal
600 x 150 mm
Cat. No. S9030103



Channel for Urinal
640 x 150 mm
Cat. No. S9030104



Urinal spreader
Cat. No. F8070201



Self closing angle
cock pressmatic for
urinal with wall
flange and 200 mm
connecting pipe
Cat. No. F9020203

SINKS



CATER
450 x 300 x 150 mm
Cat. No. S6010101*



CATER
600 x 400 x 200 mm
(660 x 460 x 200 mm including rim)
Cat. No. S6010102

CATER
600 x 400 x 250 mm
(660 x 460 x 250 mm including rim)
Cat. No. S6010103

*Ceramic parts are ISI marked products

SQUATTING PANS



ORISSA PAN (OR)

CALINA S3010101	530 x 400 mm
CALINA S3010102	580 x 440 mm*
COV S3010103	510 x 400 mm
COVY S3010104	580 x 440 mm
COY S3010105	510 x 400 mm
CLOVIS S3010106	580 x 440 mm
CLOVIN S3010108	580 x 440 mm*
COVYNA S3010109	580 x 440 mm

ORISSA PAN (BR)

CABLE S3020105	580 x 440 mm*
----------------	---------------

ORISSA PAN (CELLO)

CELIE S3030102	500 x 400 mm
----------------	--------------

TRAP



Cat. No. S9030101 Trap P

BATH ACCESSORIES - CALIFA



Shelf
Cat. No. S9010107



Soap and Shampoo Tray
Cat. No. S9010108



Soap Tray
Cat. No. S9010109



Paper Holder
Cat. No. S9010110



Towel Rail Ends Pair
with 60 cm SS Rod
Cat. No. S9010111



Robe Hook
Cat. No. S9010112

PERSONAL CARE RANGE



AUTOMATIC HAND DRYER
235 x 205 x 265 mm
(stainless steel)
Cat. No. B2220101



AUTOMATIC HAND DRYER
290 x 163 x 216 mm (ABS body)
Cat. No. B2220102



HAIR DRYER
206 x 110 x 595 mm
Cat. No. B2220103

*ISI marked products

TRAP DISTANCE

Cat. No.	Product Name	S'Trap	Concealed S'Trap	P' Trap with conv. bend*	P' Trap height
One piece EWCs with seat cover and twin flush fittings					
S1013101	CODI		220 mm		
S1013103	CODI				180 mm
S1014101	CODI		220 mm		
S1013104	COPPA		220 mm		
S1013105	CLAYTON		300 mm		
S1013106	CAPSTAN		255 mm		
S1013108	CAPSTAN				180 mm
S1013138	CAPSTAN		255 mm		
S1013139	CAPSTAN				180 mm
S1013110	CAMPBELL		110 mm		
S1013109	CAMPBELL		220 mm		
S1013111	CAMPBELL				180 mm
S1013112	CAPLE		285 mm		
S1013113	CRISTY		300 mm		
S1013114	CHARISMA		100 mm		
S1013115	CLOVER		300 mm		
S1013116	CLOVER		200 mm		
S1013117	CLOVER				160 mm
S1013119	CHRISTINA		300 mm		
S1013120	CAMAC		220 mm		
S1013122	CIMONA		300 mm		
S1013123	CLOUD		300 mm		
S1013124	CITRUS		220 mm		
S1014124	CITRUS		220 mm		
S1013125	CIROCCO		200 mm		
S1013126	CRUST		220 mm		
S1013127	CRUISER		300 mm		
S1013137	CRUISER		300 mm		
S1013129	CHISEL		220 mm		
S1013128	CHISEL		285 mm		
S1013132	CURATOR		250 mm		
S1013140	CARR		300 mm		
S1013141	CAM		250 mm		
S1013142	CAT		300 mm		
S1013143	CADMUS		300 mm		
S1013144	CARTIN		300 mm		
S1013145	CLANG		300 mm		
S1013146	CORIUM		200 mm		
S1013135	CRUSE		300 mm		
S1013136	CALIBRE		220 mm		
S1013130	CINDRELLA JUNIOR		180 mm		
Two Piece EWCs					
S1020101	CALIBRE	100 mm			
S1020102	CALIBRE				180 mm
S1021103	CALIBRE DELUXE		230 mm		
S1021104	CALLAGHAN		220 mm		
S1021105	CALLAGHAN				180 mm
S1021106	CLAIR DELUXE		120 mm		
S1020107	CLAIR	70 mm			
S1020108	CLAIR				180 mm
S1021109	CAMPBELL		120 mm		
S1021113	CRUSE		300 mm		
S1021114	CRUSE				180 mm
S1021116	CANDID		230 mm		
S1023115	CALVINA		90 mm		
S1051116	CURTIS		220 mm		
Two Piece Wall Hung EWCs					
S1031101	CALIBRE				140 mm
S1031102	CLAIR				150 mm
S1031103	CAMPBELL				195 mm
S1031104	CALLAGHAN				140 mm
S1031134	CRUSE				260 mm
S1031111	CURTIS				100 mm
Wall hung EWCs with seat cover					
S1041136	CAMPBELL CLEAN RIM				240 mm
S1046105	CAMPBELL MINI JET				220 mm
S1041137	CAMPBELL MINI				220 mm
S1044135	CARNIVAL DELUXE				240 mm
S1041106	CARNIVAL CLEAN RIM				240 mm
S1046101	CARAT with Jet				250 mm
S1041101	CARAT				250 mm
S1043128	CAMEL				230 mm
S1041132	CRYO				210 mm
S1041105	COMPACT				210 mm
S1041108	CORDO				200 mm
S1041109	CLAIR				225 mm
S1043110	CHEREE				235 mm
S1041111	CRUSE				260 mm
S1041112	COUPE				215 mm

Cat. No.	Product Name	S'Trap	Concealed S'Trap	P' Trap with conv. bend*	P' Trap height
Wall hung EWCs with seat cover					
S1043113	CROMA				195 mm
S1044113	CROMA				195 mm
S1043114	CAMEO				210 mm
S1041115	COUNTY				245 mm
S1043117	CORBET				230 mm
S1043118	CATO				200 mm
S1043119	CHEVY				205 mm
S1043120	CALICO				210 mm
S1043123	CLAREMONT				230 mm
S1043129	CLAREMONT				230 mm
Back to Wall EWC					
S1051119	CRYO				180 mm
S1051110	CAMPBELL	100 mm			
Floor Mounting					
S1050101#	CONVENTIONAL	300 mm			
S1050102#	CONVENTIONAL				180 mm
S1051103#	CAMELIA	300 mm			
S1050106#	UNIVERSAL	300 mm			
S1050107#	UNIVERSAL				180 mm
S1051108#	CIGNIA	300 mm			
S1050109#	CADE	290 mm			

Distance varies depending on the length of the Cistern bend pipe

Notes: Due to continuous upgradations, product specifications may change from time to time. Please verify the actual product for correct specifications, before purchase. • Please see physical product before final selection. • Warranty of the product will become null and void if the installation is not done as recommended and/or if not done by qualified technicians. • The colours of ceramic/plastic/stainless steel products and those of printing inks do not match exactly. Therefore, colour selection may be done from actual products. • Whilst every precaution is taken in the compilation of our catalogue, we do not accept responsibility for any error or omission. • All dimensions are in millimetre (nominal) • Dimensional variations are inherent to ceramic products and tolerances may be $\pm 2\%$ or as allowed/specified by BIS or company's quality norms. • Sizes mentioned are approximations only. For exact product size refer to the respective technical drawings.

CERA
Faucets





INDEX

OLD CAT. NO.	NEW CAT. NO.	NAME	PAGE NO.
GARNET Quarter turn			
CL 201	F2002101	Pillar cock	135
CL 203	F2002151	Bib cock	135
CL 204	F2002152	Bib cock long nose	135
CL 205	F2002211	2-way angle cock	135
	F2002163	2-way bib cock	135
CL 208	F2002201	Angle cock	135
CL 209	F2002103	Pillar cock high neck	135
CL 210	F2002403	Wall mixer 3-in-1 with telephonic & overhead shower arrangement	136
CL 211	F2002404	Wall mixer with telephonic shower arrangement	136
CL 212	F2002401	Wall mixer 2-in-1	136
CL 213	F2002405	Wall mixer (non shower arrangement)	136
CL 215	F2002461	Central hole basin mixer	136
CL 217	F2002261	Sink cock (wall mounted) with swivel spout	135
CL 219	F2002511	Sink mixer (wall mounted) with swivel spout	136
CL 222L	F2002104	Pillar cock with swan neck spout - left	135
CL 222R	F2002105	Pillar cock with swan neck spout - right	135
CL 227	F2002361	Stop cock - 15 mm	136
CL 228	F2002362	Stop cock - 20 mm	136
CL 251E	F2002751	Flush cock - exposed set	136
CFC 101	F4060101	Flush cock - concealed part	136
CFC 102	F4060102	Flush cock - concealed part	136
OCEAN Half turn			
CC 101	F3001101	Pillar cock	131
CC 103	F3001151	Bib cock	131
CC 104	F3001152	Bib cock long nose	131
CC 105	F3001211	2-way angle cock	131
CC 106B	F3001163	2-way bib cock - single knob	131
CC 108	F3001201	Angle cock	131
CC 108A	F3001202	Angle cock (small)	131
CC 109	F3001103	Pillar cock with high neck	131
CC 110	F3001403	Wall mixer 3-in-1 with telephonic & overhead shower arrangement	132
CC 111	F3001404	Wall mixer with telephonic shower arrangement	132
CC 112	F3001401	Wall mixer	132
CC 112B	F3001402	Wall mixer with built-in non return valve	132
CC 113	F3001405	Wall mixer (non shower arrangement)	132
CC 115A	F3001461	Central hole basin mixer	132
CC 117	F3001251	Sink cock (wall mounted) with swivel spout	132
CC 119	F3001501	Sink mixer (wall mounted) with swivel spout	132
CC 122L	F3001104	Pillar cock with swan neck spout - left	131
CC 122R	F3001105	Pillar cock with swan neck spout - right	131
CC 126	F3001581	Central hole sink mixer	133
CC 127E	F3001351	Stop cock - exposed set	132
CSC 151	F4050102	Stop cock - concealed part 15 mm	132
CSC 201	F4050502	Stop cock - concealed part 20 mm	132
CC 151E	F3001751	Flush cock - exposed set	132
CFC 101	F4060101	Flush cock - concealed part	132
CFC 102	F4060102	Flush cock - concealed part	132
FLORAL Half turn			
CP 101	F3002101	Pillar cock	138
CP 103	F3002151	Bib cock	138
CP 104	F3002152	Bib cock long body	138
CP 106	F3002211	2-way angle cock	138
CP 108	F3002201	Angle cock	138
CP 109A	F3002103	Pillar cock high neck	138
CP 110	F3002403	Wall mixer 3-in-1 with telephonic & overhead shower arrangement	139
CP 111	F3002404	Wall mixer with telephonic shower arrangement	139
CP 112	F3002401	Wall mixer	139
	F3002163	2-way bib cock	139
CP 115	F3002461	Central hole basin mixer	139
CP 117	F3002261	Sink cock (wall mounted) with swivel spout	138
CP 119	F3002511	Sink mixer (wall mounted) with swivel spout	139
CP 122L	F3002104	Pillar cock with swan neck spout - left	138
CP 122R	F3002105	Pillar cock with swan neck spout - right	138

INDEX

OLD CAT. NO.	NEW CAT. NO.	NAME	PAGE NO.
Overhead rain showers- ABS			
CG 408B	F7010601	Overhead rain shower 200 mm dia (8")	145
CG 409B	F7010501	Overhead rain shower square 180 x 180 mm (7" x 7")	144
CG 410	F7010602	Overhead rain shower 230 mm dia (9")	145
CG 411	F7010502	Overhead rain shower square 200 x 200 mm (8" x 8")	144
CG 412	F7010503	Overhead rain shower square 200 x 200 mm (8" x 8")	144
CG 413	F7010504	Overhead rain shower square 100 x 100 mm (4" x 4")	145
CG 414	F7010505	Overhead rain shower square 200 x 200 mm (8" x 8")	145
CG 415	F7010506	Overhead rain shower square 150 x 150 mm (6" x 6")	145
CG 417	F7010507	Overhead rain shower square 200 x 200 mm (8" x 8")	145
CG 421	F7010508	Overhead rain shower square 200 x 200 mm (8" x 8")	145
CG 422	F7010509	Overhead rain shower rectangular 300 x 200 mm (12"x8")	145
CG 424	F7010510	Overhead rain shower rectangular 260 x 190 mm (10"x8")	145
CG 429	F7010603	Overhead rain shower 200 mm dia (8")	145
CG 431	F7010604	Overhead rain shower 200 mm dia (8")	145
CG 433	F7010511	Overhead rain shower rectangular 260 x 190 mm (10"x8")	146
Overhead showers with/without arm			
CC 140	F7020101	Overhead shower 60 mm (2.5") with revolving joint	146
CG 301	F7020102	Overhead shower 85 mm (3.5") dia with single flow	146
CG 404	F7020103	Overhead shower 70 mm (2.5")	146
CG 405	F7020301	Overhead shower 80 mm (3") with 3 flow	146
CG 406	F7020302	Overhead shower 95 mm (4") with 3 flow	146
CG 407	F7020303	Overhead shower 80 mm (3") with 3 flow	146
CG 416A	F7020304	Overhead shower 95 mm (4") with 3 flow	146
CG 416B	F7020305	Overhead shower 120 mm (5") with 3 flow	146
CG 452	F7020306	Overhead shower 100 mm (4")	146
CG 452A	F7020307	Overhead shower 100 mm (4")	146
CP 140	F7020104	Overhead shower 70 mm (2.5") dia with shower arm	146
CQ 140	F7020105	Overhead shower 70 mm (2.5") dia with revolving joint	146
CQ 440	F7020106	Overhead shower 65 mm (2.5") dia with revolving joint	146
Telephonic hand showers with/without hook and hose			
CG 302	F7030105	Hand shower 90 mm (4") dia with 125 mm (5") long arm	147
CG 425	F7030101	Hand shower in size 100 x 55 mm (4" x 2") with 130 mm (5") long arm	147
CG 430	F7030104	Hand shower 90 mm (4") dia with 3 flow and 140 mm (5.5") long arm	147
CG 432	F7030103	Hand shower 90 mm (4") dia with 3 flow and 140 mm (5.5") long arm	147
CG 434	F7030102	Hand shower in size 100 x 55 mm (4" x 2") with 130 mm (5") long arm	147
CH 402	F7030106	Hand shower square 66 mm (2.5") dia with 3 flow and 135 mm (5.5") long arm	147
CP 141	F7030301	Telephonic hand shower 70 mm (3") dia with wall hook and 1.5 metre hose	147
Shower arms - Stainless steel			
CH 102	F7040101	Overhead shower arm 180 mm (7") with flange	147
CH 103	F7040102	Overhead shower arm 200 mm (8") with flange	147
Shower arms - Brass			
CH 106	F7040103	Overhead shower arm 230 mm (9") with flange	148
CH 107	F7040106	Overhead shower arm 450 mm (18") with flange	148
CH 108	F7040104	Overhead shower arm 305 mm (12") with flange	148
CH 109	F7040105	Overhead shower arm 380 mm (15") with flange	148
CH 110-7	F7040201	Overhead shower arm 180 mm (7") with wall flange	148
CH 110-12	F7040202	Overhead shower arm 305 mm (12") with wall flange	148
CH 110-15	F7040203	Overhead shower arm 380 mm (15") with wall flange	148
Bath tub spouts with/without bottom arrangement			
CQ 124	F2001661	Bathtub spout with flange	148
CQ 125	F2001662	Bathtub spout with flange and button arrangement for telephonic shower	148
CQ 424	F2004661	Bath tub spout with flange	148
CQ 425	F2004662	Bath tub spout with flange and button arrangement for telephonic shower	148
Allied product			
CG 121A	F9040101	Pillar cock with spatula lever and aerator	148

OLD CAT. NO.	NEW CAT. NO.	NAME	PAGE NO.
Flush valves			
CM 102	F8010101	Flush valve push type (single flush) 400 mm (1.5")	149
CM 102S	F8010102	Flush valve push type (single flush) 40 mm (1.5")	149
CM 202	F8010201	Flush valve push type (dual flush) 40 mm (1.5")	149
CM 202S	F8010202	Flush valve push type (dual flush) 40 mm (1.5")	149
CM 302	F8010103	Flush valve push type (single flush) 32 mm (1.25")	149
CM 302S	F8010104	Flush valve push type (single flush) 32 mm (1.25")	149
CM 401A	F8010301	Flush valve exposed type	149
CM 402	F8010203	Flush valve push type (dual flush) 32 mm (1.25")	149
CM 402S	F8010105	Flush valve push type (dual flush) 32 mm (1.25")	149
CM 502	F8010106	Flush valve push type (single flush) 25 mm (1")	149
CM 502S	F8010107	Flush valve push type (single flush) 25 mm (1")	149
	F8010108	Flush valve push type (single flush) 32 mm (1.25")	149
Control Valve			
	F8015101	Control Valve with knob 25 mm dia	149
Flush cock			
CM 101E	F8020751	Flush cock - exposed set	150
CM 201	F8020201	Flush cock 1 inch lever	150
CM 301	F8020301	Flush cock 1 inch push	150
CQ 452E	F2004753	Flush cock - exposed set	150
Angle cock			
CM 108	8040201	Angle cock	150
CM 108B	F8040203	Angle cock	150
CM 108C	F8040204	Angle cock	150
CM 109	F8040205	Angle cock	150
Health faucets			
CG 105	F8030101	Health faucet ABS body	150
CG 105A	F8030301	Health faucet brass body	151
CG 105B	F8030202	Health faucet ABS body (push type)	151
CG 106	F8030102	Health faucet ABS body	150
CG 205	F8030103	Health faucet ABS body	150
	F8030401 AB	Health Faucet POM	151
HERA bath accessories			
CA 701	F5007101	Towel rack 600 mm (24")	150
CA 702	F5007102	Towel rack 450 mm (18")	150
CA 703	F5007103	Towel rail 600 mm (24")	150
CA 704	F5007104	Towel rail 450 mm (18")	150
CA 705	F5007105	Towel ring	150
CA 706	F5007106	Soap dish	150
CA 707	F5007107	Tumbler holder	150
CA 708	F5007108	Robe hook	150
CA 709	F5007109	Paper holder	150
CA 710	F5007110	Paper holder with flap guard	150
CA 711	F5007111	Liquid soap dispenser	150
MONTANA bath accessories			
CA 201	F5002101	Towel rack 600 mm (24")	152
CA 202	F5002102	Towel rack 450 mm (18")	152
CA 203	F5002103	Towel rail 600 mm (24")	152
CA 204	F5002104	Towel rail 450 mm (18")	152
CA 205	F5002105	Towel ring	152
CA 206	F5002106	Soap dish	152
CA 207	F5002107	Tumbler holder	152
CA 208	F5002108	Robe hook	152
CA 209	F5002109	Paper holder	152
CA 210	F5002110	Paper holder with flap guard	152
CA 211	F5002111	Liquid soap dispenser	152
ORMOND bath accessories			
CA 301	F5003101	Towel rack 600 mm (24")	152
CA 302	F5003102	Towel rack 450 mm (18")	152
CA 303	F5003103	Towel rail 600 mm (24")	152
CA 304	F5003104	Towel rail 450 mm (18")	152
CA 305	F5003105	Towel ring	152
CA 306	F5003106	Soap dish	152
CA 307	F5003107	Tumbler holder	152
CA 308	F5003108	Robe hook	152
CA 310	F5003110	Paper holder with flap guard	153
CA 312	F5003112	Coat hook 4	153
CA 313	F5003113	Coat hook 6	153

INDEX

OLD CAT. NO.	NEW CAT. NO.	NAME	PAGE NO.
VERMONT bath accessories			
CA 401	F5004101	Towel rack 600 mm (24")	153
CA 402	F5004102	Towel rack 450 mm (18")	153
CA 403	F5004103	Towel rail 600 mm (24")	153
CA 404	F5004104	Towel rail 450 mm (18")	153
CA 405	F5004105	Towel ring	153
CA 406	F5004106	Soap dish	153
CA 407	F5004107	Tumbler holder	153
CA 408	F5004108	Robe hook	153
CA 409	F5004109	Paper holder	153
CA 410	F5004110	Paper holder with flap guard	153
OCEANA bath accessories			
CA 501	F5005101	Corner glass shelf (small) 150 x 150 mm (6" x 6")	153
CA 502	F5005102	Corner glass shelf (medium) 225 x 225 mm (9" x 9")	153
CA 503	F5005103	Corner glass shelf (large) 300 x 300 mm (12" x 12")	153
CA 505	F5005201	Corner glass shelf with two racks	154
CA 504	F5005301	Glass shelf with towel rail	154
CA 521	F5005501	Acrylic corner shelf (small) 150 x 150 mm (6" x 6")	154
CA 522	F5005502	Acrylic corner shelf (medium) 225 x 225 mm (9" x 9")	154
CA 523	F5005503	Acrylic corner shelf (large) 300 x 300 mm (12" x 12")	154
OAKLEY bath accessories			
CA 601	F5006101	Towel rack 600 mm (24")	154
CA 602	F5006102	Towel rack 450 mm (18")	154
CA 603	F5006103	Towel rail 600 mm (24")	154
CA 604	F5006104	Towel rail 450 mm (18")	154
CA 605	F5006105	Towel ring	154
CA 606	F5006106	Soap dish	154
CA 607	F5006107	Tumbler holder	154
CA 608	F5006108	Robe hook	154
CA 609	F5006109	Paper holder	154
CA 610	F5006110	Paper holder with flap guard	154
Bath accessories			
CA 101	F5001103	Towel rail 24"	155
CA 102	F5001105	Towel ring	155
CA 103	F5001106	Soap dish	155
CA 104	F5001107	Tumbler holder	155
CA 105	F5001108	Robe hook	155
CA 106	F5001109	Toilet paper holder	155
CA 107	F5001101	Towel rack 24"	155
CA 108	F5001114	Glass shelf	155
Bath products auxiliaries			
CG 103	F8070101	Hand shower holder	155
CG 103A	F8070102	Brass shower hook	155
CG 104	F8070401	1.5 metre flexible stainless steel hose	155
CG 107	F8070402	Polyamid braided connection pipe 12mm dia	155
CG 107A	F8070403	Geyser connection braided pipe	155
CG 501	F8070201	Urinal spreader	155
CM 107	F8070301	Extension nipple 15 mm dia (1/2"), 25 mm (1") length	155
CM 107A	F8070302	Extension nipple 15 mm dia (1/2"), 35 mm (1.5") length	155
CM 107B	F8070303	Extension nipple 15 mm dia (1/2"), 50 mm (2") length	155
CM 107C	F8070304	Extension nipple 15 mm dia (1/2"), 65 mm (2.5") length	155
CM 107D	F8070305	Extension nipple 15 mm dia (1/2"), 75 mm (3") length	155
CM 107E	F8070306	Extension nipple 15 mm dia (1/2"), 100 mm (4") length	155
CM 107F	F8070307	Extension nipple 15 mm dia (1/2"), 150 mm (6") length	155
Bottle trap			
CM 104	F8060101	Bottle trap 150 mm (6")	156
CM 104A	F8060301	Bottle trap 228 mm (9")	156
CM 104B	F8060401	Bottle trap 300 mm (12")	156
CM 104D	F8060201	Bottle trap 178 mm (7")	156
CM 104E	F8060302	Bottle trap 228 mm (9")	156
CM 104F	F8060403	Bottle trap 300 mm (12")	156
Aquamatic			
CG 111	F9020203	Self closing angle cock pressmatic for urinal with bend pipe	156
CG 601	F9020101	Pillar cock pressmatic	156
CG 603	F9020151	Bib cock pressmatic	156
CG 608	F9020201	Angle cock pressmatic with flange	156

OLD CAT. NO.	NEW CAT. NO.	NAME	PAGE NO.
Waste coupling			
CG 422A	F8050501	Waste coupling with pop-up for bath tub	156
CM 103	F8050101	Waste coupling full thread	156
CM 113	F8050301	Waste coupling 32mm with 125mm length (full thread)	156
CM 203	F8050102	Waste coupling half thread	156
CM 303C	F8050351	Waste coupling with ceramic pop-up push type	156
CS 423	F8050451	Waste coupling with pop-up (full thread)	156
Clinical			
CQ 504	F9030152	Bib cock long body with flange and 200 mm lever handle	156
CQ 515	F9030451	Spactula Single Lever Faucet	156

CERA

NEW ARRIVALS

KITCHEN SINK FAUCETS



Caabul (Satin SS)
Pillar cock with 374 mm (15")

F1031302



Caavi (Satin SS with Green)
Pillar cock with 374 mm (15")

F1032302



Caachi (Satin SS with Orange)
Pillar cock with 374 mm (15")

F1033302

HEALTH FAUCETS



Health Faucet POM with
1.2 metre braided hose pipe

F8030401AB



SENSOR TAPS



Sensor tap (with control box set)
F6010101



Sensor tap (with control box set)
F6010102



Sensor tap (with control box set)
F6010103



Signature
Sensor Touch Tap (with control box set)
F6020101













Sensor Touch Tap (with control box set)
F6020102

PERLA
SINGLE LEVER / QUARTER TURN RANGE



PERLA SINGLE LEVER / QUARTER RANGE

CERA

<p>GREEN WEP-I WATER RATING</p>  <p>F1012101 Pillar cock with aerator</p>	<p>GREEN WEP-I WATER RATING</p>  <p>F1012151 Bib cock with wall flange and aerator</p>	<p>GREEN WEP-I WATER RATING</p>  <p>F1012163 2-way Bib cock with single handle and wall flange</p>	<p>GREEN WEP-I WATER RATING</p>  <p>F1012201 Angle cock with wall flange</p>
<p>GREEN WEP-I WATER RATING</p>  <p>F1012401 Wall mixer with 210 mm (8.5") long bend pipe for overhead shower</p>	<p>GREEN WEP-I WATER RATING</p>  <p>F1012451 Single lever basin mixer with 450 mm braided connection pipe (without pop-up)</p>	<p>GREEN WEP-I WATER RATING</p>  <p>F1012261 Sink cock (wall mounted) with 200 mm (8") long swivel spout and wall flange</p>	
<p>GREEN WEP-I WATER RATING</p>  <p>F1012511 Sink mixer (wall mounted) with 200 mm (8") long swivel spout connecting legs and wall flanges</p>	<p>GREEN WEP-I WATER RATING</p>  <p>F1012661 Bath tub spout with wall flange</p>	<p>GREEN WEP-I WATER RATING</p>  <p>Concealed part for concealed stop cock suitable for 15 and 20 mm pipeline with inner head (without exposed part) F4050102 15 mm F4050103 15 mm F4050502 20 mm F4050503 20 mm</p>	

PERLA SINGLE LEVER / QUARTER RANGE



Exposed part of stop cock consisting sleeve, lever and flange
 Exposed part F1012351
 Concealed part-15 mm F4050102

Light weight concealed part-15 mm F4050103

Exposed part F1012351
 Concealed part-20 mm F4050502

Light weight concealed part-20 mm F4050503



F4020101
 Concealed body for 5-way single lever concealed diverter system consisting of cartridge with button Assembly, Cartridge Sleeve (but without operating lever, wall flange and tip ton knob)



Exposed part of 5-way single lever concealed diverter with lever, tip ton knob and flange
 Exposed part F1012711
 Concealed part F4020101

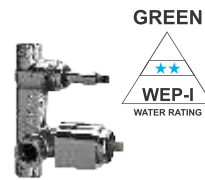

F4010106
 Concealed body for turn type single lever concealed diverter system consisting of 35 mm cartridge with button assembly, Cartridge sleeve (but without operating lever, wall flange and tip ton knob)



Exposed part of single lever concealed diverter with lever, turn type knob and 2 mm thick sheet metal wall flange and concealed part
 Exposed part F1012702
 Concealed part F4010106



F4030101
 Concealed body for high flow single lever, concealed diverter system consisting of 45 mm cartridge with button Assembly, Cartridge Sleeve (but without operating lever, wall flange and tip ton knob)



Exposed part of high flow single lever concealed diverter with lever, tip ton knob and flange
 Exposed part F1012721
 Concealed Part F4030101



F4060102
 F4060101
 Concealed body for flush cock consisting of concealed body and cartridge (but without operating lever, cartridge sleeve and wall flange)



Exposed part of flush cock consisting lever, cartridge sleeve and flange
 Exposed part F1012751
 Concealed part F4060102

Concealed part F4060101

VALENTINA
 SINGLE LEVER / QUARTER TURN RANGE

CERA



VALENTINA SINGLE LEVER / QUARTER TURN RANGE

CERA



F1013101
Pillar cock with aerator



F1013451
Single lever basin mixer with 450 mm braided connection pipe (without pop-up)



F1013452
Single lever basin mixer with 305 mm (12") extended body and 450 mm braided connection pipe (without pop-up)



F1013151
Bib cock with wall flange and aerator



F1013201
Angle cock with wall flange



F1013411
Single lever wall mixer (2-in-1) with provision for telephonic shower arrangement



F1013414
Single lever wall mixer (2-in-1) with provision for telephonic shower arrangement



F1013551
Single lever Sink mixer (table mounted) with 235 mm (9") long swivel spout and 450 mm long braided connection pipe



F1013661
Bath tub spout with wall flange



Concealed part for concealed stop cock suitable for 15 and 20 mm pipeline with inner head (without exposed part)
F4050102 15 mm
F4050103 15 mm
F4050502 20 mm
F4050503 20 mm



Exposed part of stop cock consisting sleeve, lever and flange
Exposed part F1013351
Concealed part-15 mm F4050102

Light weight concealed part-15 mm F4050103

Exposed part F1013351
Concealed part-20 mm F4050502

Light weight concealed part-20 mm F4050503



Concealed body for turn type single lever concealed diverter system consisting of 35 mm cartridge with button assembly, Cartridge sleeve (but without operating lever, wall flange and tip ton knob)



F4010107



Exposed part of single lever concealed diverter with lever, turn type knob and 2 mm thick sheet metal wall flange and concealed part
Exposed part F1013702
Concealed part F4010107



Concealed body for 5-way single lever concealed diverter system consisting of cartridge with button Assembly, Cartridge Sleeve (but without operating lever, wall flange and tip ton knob)

F4020101



Exposed part of 5-way single lever concealed diverter with lever, tip ton knob and flange
Exposed part F1013711
Concealed part F4020101



Concealed body for high flow single lever, concealed diverter system consisting of 45 mm cartridge with button Assembly, Cartridge Sleeve (but without operating lever, wall flange and tip ton knob)

F4030101



Exposed part of high flow single lever concealed diverter with lever, tip ton knob and flange
Exposed part F1013721
Concealed Part F4030101



Concealed body for flush cock consisting of concealed body and cartridge (but without operating lever, cartridge sleeve and wall flange)

F4060102
F4060101

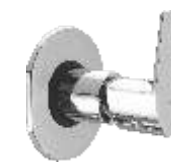

Exposed part of flush cock consisting lever, cartridge sleeve and flange
Exposed part F1013751
Concealed part F4060102

Concealed part F4060101

GAYLE
SINGLE LEVER / QUARTER TURN RANGE



GAYLE SINGLE LEVER / QUARTER TURN RANGE

CERA



F1014101

Pillar cock with aerator



F1014102

Pillar cock with 310 mm (12.5") long extended body and aerator



F1014106

Pillar cock with swivel swan neck spout and aerator



F1014151

Bib cock with wall flange and aerator



F1014201

Angle cock with wall flange



F1014152

Bib cock long nose with wall flange and aerator



F1014161

2-way bib cock with wall flange and aerator



F1014251

Sink cock (wall mounted) with 150 mm (6") long swivel spout and wall flange



F1014311

Sink cock (table mounted) with 232 mm (9") long swivel spout

GAYLE SINGLE LEVER / QUARTER TURN RANGE



Concealed part for concealed stop cock suitable for 15 and 20 mm pipeline with inner head (without exposed part) F4050102
15 mm
F4050103 15 mm
F4050502 20 mm
F4050503 20 mm



Exposed part of stop cock consisting sleeve, lever and flange
Exposed part F1014351
Concealed part-15 mm F4050102
Light weight concealed part-15 mm F4050103
Exposed part F1014351
Concealed part-20 mm F4050502
Light weight concealed part-20 mm F4050503



F1014402
F1014401

Wall mixer with bend pipe for overhead shower with built-in non return valve
Wall mixer with bend pipe for overhead shower



F1014451

Single lever basin mixer with 450 mm braided connection pipe (without pop-up)



F1014452

Single lever basin mixer with 305 mm (12") long extended body and 450 mm braided connection pipe (without pop-up)



F1014501

Sink mixer (wall mounted) with 150 mm (6") long swivel spout, connecting legs and wall flanges



F1014411

Single lever wall mixer with bend pipe for overhead shower



F1014414

Single lever wall mixer with provision for telephonic shower arrangement



F1014471

Wall mounted single lever basin mixer with box wall flange with concealed mixer body



F1014551

Single lever sink mixer (table mounted) with 235 mm (9") long swivel spout and 450 mm long braided connection pipe



F4010103

Concealed body for single lever, concealed diverter system consisting of 35 mm cartridge with button Assembly, Cartridge Sleeve (but without operating lever, wall flange and tip ton knob)



Exposed part of single lever concealed diverter with lever, tip ton knob and 2 mm sheet flange
Exposed part F1014702
Concealed Part F4010103



F1014472

Wall mounted single lever basin mixer with 2.0 mm thick sheet metal wall flange with concealed mixer body



F1014651

Wall mounted basin spout and operating lever with wall flanges (concealed single body)



F1014661

Bath tub spout with wall flange



Exposed part of single lever concealed diverter with lever, tip ton knob and flange
Exposed part F1014701
Concealed Part F4010103



F4020101

Concealed body for 5-way single lever, concealed diverter system consisting of cartridge with button Assembly, Cartridge Sleeve (but without operating lever, wall flange and tip ton knob)



Exposed part of 5-way single lever concealed diverter with lever, tip ton knob and 2 mm sheet flange
Exposed part F1014712
Concealed Part F4020101

GAYLE SINGLE LEVER / QUARTER TURN RANGE



Exposed part of 5-way single lever concealed diverter with lever, tip ton knob and flange
Exposed part F1014711
Concealed Part F4020101



F4030101
Concealed body for high flow single lever, concealed diverter system consisting of 45 mm cartridge with button Assembly, Cartridge Sleeve (but without operating lever, wall flange and tip ton knob)

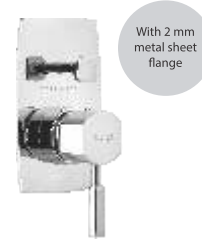

With 2 mm metal sheet flange
Exposed part of high flow single lever concealed diverter with lever, tip ton knob and 2 mm sheet flange
Exposed part F1014722
Concealed Part F4030101



Exposed part of high flow single lever concealed diverter with lever, tip ton knob and flange
Exposed part F1014721
Concealed Part F4030101



Concealed body for flush cock consisting of concealed body and cartridge (but without operating lever, cartridge sleeve and wall flange)
Concealed Part F4060102
Concealed Part F4060101



Exposed part of flush cock consisting lever, cartridge sleeve and flange
Exposed part F1014751
Concealed Part F4060102
Concealed Part F4060101

RUBY SINGLE LEVER / QUARTER TURN RANGE

CERA



RUBY SINGLE LEVER / QUARTER TURN RANGE



F1005101
Pillar cock with aerator



F1005151
Bib cock with wall flange and aerator



F1005152
Bib cock long nose with wall flange and aerator



F1005161
2-Way bib cock with wall flange and aerator

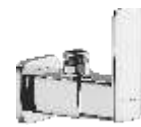

F1005201
Angle cock with wall flange



F1005251
Sink cock (wall mounted) with 150 mm (6") long swivel spout and wall flange



F1005402
Wall mixer with bend pipe for overhead shower with built-in non return valve

F1005401
Wall mixer with bend pipe for overhead shower



F1005424
Single lever wall mixer with 90° swivel spout and provision for telephonic shower arrangement



F1005451
Single lever basin mixer with 450 mm braided connection pipe and provision for pop-up



F1005452
Single lever basin mixer with 305 mm (12") extended body and 450 mm braided connection pipe (without pop-up)



F1005471
Wall mounted single lever basin mixer with wall flange (concealed single body mixer)



F1005501
Sink mixer (wall mounted) with 150 mm (6") long swivel spout and wall flange



F1005651
Wall mounted basin spout and operating lever with wall flanges (concealed single body)



F1005661
Bath tub spout with wall flange



F1005662
Bath tub spout with wall flange and button arrangement for telephonic shower



F4010103
Concealed body for single lever concealed diverter system consisting of 35 mm cartridge with button Assembly, Cartridge Sleeve (but without operating lever, wall flange and tip ton knob)



F1005701
Exposed part of single lever concealed diverter with lever, tip ton knob and flange
Concealed part F4010103



F4020101
Concealed body for 5-way single lever concealed diverter system consisting of cartridge with button Assembly, Cartridge Sleeve (but without operating lever, wall flange and tip ton knob)

CERA

RUBY SINGLE LEVER / QUARTER TURN RANGE



Exposed part of 5-way single lever concealed diverter with lever, tip ton knob and flange
 Exposed part F1005711
 Concealed part F4020101



F4030101
 Concealed body for high flow single lever concealed diverter system consisting of 45 mm cartridge with button Assembly, Cartridge Sleeve (but without operating lever, wall flange and tip ton knob)



Exposed part of high flow single lever concealed diverter with lever, tip ton knob and flange
 Exposed part F1005721
 Concealed part F4030101



F4060102
 F4060101
 Concealed body for flush cock consisting of concealed body and cartridge (but without operating lever, cartridge sleeve and wall flange)



Exposed part of flush cock consisting lever, cartridge sleeve and flange
 Exposed part F1005751
 Concealed part F4060102
 Concealed part F4060101



Concealed part for concealed stop cock suitable for 15 and 20 mm pipeline with inner head (without exposed part)
 F4050102 15 mm
 F4050103 15 mm
 F4050502 20 mm
 F4050503 20 mm



Exposed part of stop cock consisting sleeve, lever and flange
 Exposed part F1005351
 Concealed part-15 mm F4050102

Light weight concealed part-15 mm F4050103

Exposed part F1005351
 Concealed part-20 mm F4050502

Light weight concealed part-20 mm F4050503

TOPAZ
 SINGLE LEVER / QUARTER TURN RANGE



TOPAZ SINGLE LEVER / QUARTER TURN RANGE



F1007101

Pillar cock with aerator



F1007151

Bib cock with wall flange and aerator



F1007152

Bib cock long nose with wall flange and aerator



F1007452

Single lever basin mixer with 317 mm (12.5") extended height and 450 mm braided connection pipe (without pop-up)



F1007661

Bath tub spout with wall flange



F4010101

Concealed body for single lever concealed diverter system consisting of 40 mm cartridge with button Assembly, Cartridge Sleeve (but without operating lever, wall flange and tip ton knob)



F1007201

Angle cock with wall flange



Concealed part for concealed stop cock suitable for 15 and 20 mm pipeline with inner head (without exposed part)
F4050102 15 mm
F4050103 15 mm
F4050502 20 mm
F4050503 20 mm

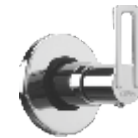

Exposed part of stop cock consisting sleeve, lever and flange & concealed part

Exposed part F1007351
Concealed part-15 mm F4050102

Light weight concealed part-15 mm F4050103

Exposed part F1007351
Concealed part-20 mm F4050502

Light weight concealed part-20 mm F4050503



Exposed part of single lever concealed diverter with lever, tip ton knob and flange

Exposed part F1007701
Concealed part F4010101



F4010105

Concealed body for turn type single lever concealed diverter system consisting of 35 mm cartridge with button Assembly, Cartridge Sleeve (but without operating lever, wall flange and tip ton knob)



Exposed part of single lever concealed diverter with lever, turn type knob and flange

Exposed part F1007703
Concealed part F4010105



F1007413

Wall mixer (3-in-1) with arrangement for both telephonic shower and overhead shower with 210 mm (8.5") max long bend pipe



F1007414

Single lever wall mixer with provision for telephonic shower arrangement



F1007451

Single lever basin mixer with 450 mm braided connection pipe (without pop-up)



F4020101

Concealed body for 5-way single lever concealed diverter system consisting of cartridge with button Assembly, Cartridge Sleeve (but without operating lever, wall flange and tip ton knob)



Exposed part of 5-way single lever concealed diverter with lever, tip ton knob and flange

Exposed part F1007711
Concealed part F4020101



F4030101

Concealed body for high flow single lever concealed diverter system consisting of 45 mm cartridge with button Assembly, Cartridge Sleeve (but without operating lever, wall flange and tip ton knob)

TOPAZ SINGLE LEVER / QUARTER TURN RANGE



Exposed part of high flow single lever concealed diverter with lever, tip ton knob and flange
Exposed part F1007721
Concealed part F4030101



Concealed body for flush cock consisting of concealed body and cartridge (but without operating lever, cartridge sleeve and wall flange)
F4060102
F4060101



Exposed part of flush cock consisting lever, cartridge sleeve and flange
Exposed part F1007751
Concealed part F4060102
Concealed part F4060101



F1007771
Single lever wall mixer (3-in-1) with exposed shower pipe, spout fitted with F7010102 overhead rain shower, F7030103 telephonic hand shower and F8070401 1.5 metre flexible stainless steel hose

TOPAZ SINGLE LEVER / QUARTER TURN RANGE

CERA



F2007101
Pillar cock with aerator



F2007103
Pillar cock high neck with aerator



F2007104 (Left)
F2007105 (Right)
Pillar cock with swan neck spout (left/right) and aerator



F2007151
Bib cock with wall flange and aerator



F2007161
2-Way bib cock with wall flange and aerator



F2007162
2-Way bib cock with wall flange and aerator



F2007201
Angle cock with wall flange



F2007211
2-Way angle cock with wall flange



F2007251
Sink cock (wall mounted) with 150 mm (6") long swivel spout and wall flange

TOPAZ SINGLE LEVER / QUARTER TURN RANGE



F2007301

Sink cock (table mounted) with 171 mm (7") long swivel spout



Concealed part for concealed stop cock suitable for 15 and 20 mm pipeline with inner head (without exposed part)
 F4050102 15 mm
 F4050103 15 mm
 F4050502 20 mm
 F4050503 20 mm



Exposed part of stop cock consisting sleeve, lever and flange

Exposed part F2007351
 Concealed part-15 mm F4050102

Light weight concealed part-15 mm F4050103

Exposed part F2007351
 F4050502

Light weight concealed part-20 mm F4050503



Wall mixer with bend pipe for overhead shower with built-in non return valve
 F2007402

Wall mixer with bend pipe for overhead shower
 F2007401



F2007403

Wall mixer (3-in-1) with arrangement for both telephonic shower and overhead shower with bend pipe



F2007404

Wall mixer with telephonic shower arrangement



F2007461

Central hole basin mixer with 450 mm braided connection pipe (without pop-up)



F2007501

Sink mixer (wall mounted) with 150 mm (6") long swivel spout, connecting legs and wall flanges



F4060102
 F4060101

Concealed body for flush cock consisting of concealed body and cartridge (but without operating lever, cartridge sleeve and wall flange)



Exposed part of flush cock consisting lever, cartridge sleeve and flange

Exposed part F2007751
 Concealed part F4060102

Light weight concealed part F4060101

TITANIUM SINGLE LEVER / QUARTER TURN RANGE

CERA



TITANIUM SINGLE LEVER / QUARTER TURN RANGE

CERA



F1003101

Pillar cock with aerator



F1003102

Pillar cock with 300 mm (12") long extended body with aerator



F1003103

Pillar cock high neck with aerator



F1003251

Sink cock (wall mounted) with 150 mm (6") long swivel spout and wall flange



F1003261

Sink cock (wall mounted) with 200 mm (8") swivel spout and wall flange



Concealed part for concealed stop cock suitable for 15 and 20 mm pipeline with inner head (without exposed part)
F4050102 15 mm
F4050103 15 mm
F4050502 20 mm
F4050503 20 mm



F1003104 (Left)
F1003105 (Right)

Pillar cock with swan neck spout (left/right) and aerator



F1003151

Bib cock with wall flange and aerator



F1003161

2-Way bib cock with wall flange and aerator



Exposed part of stop cock consisting sleeve, lever and flange & concealed part

Exposed part F1003351
Concealed part-15 mm F4050102

Light weight concealed part-15 mm F4050103

Exposed part F1003351
Concealed part-20 mm F4050502

Light weight concealed part-20 mm F4050503



Wall mixer with bend pipe for overhead shower with built-in non return valve
F1003402

Wall mixer with bend pipe for overhead shower
F1003401



F1003403

Wall mixer (3-in-1) with arrangement for both telephonic shower and overhead shower with bend pipe



F1003162

2-Way bib cock with wall flange and aerator



F1003201

Angle cock with wall flange



F1003211

2-Way angle cock with wall flange



F1003404

Wall mixer with telephonic shower arrangement



F1003415

Single lever wall mixer with shower arrangement only



F1003451

Single lever basin mixer with 450 mm braided connection pipe and provision for pop-up

TITANIUM SINGLE LEVER / QUARTER TURN RANGE



F1003461

Central hole basin mixer with 450 mm braided connection pipe (without pop-up)



F1003501

Sink mixer (wall mounted) with 150 mm (6") long swivel spout, connecting legs and wall flanges



F1003511

Sink mixer (wall mounted) with 200 mm (8") swivel spout, connecting legs and wall flanges



F4020101

Concealed body for 5-way single lever concealed diverter system consisting of cartridge with button Assembly, Cartridge Sleeve (but without operating lever, wall flange and tip ton knob)



Exposed part of 5-way single lever concealed diverter with lever, tip ton knob and flange
Exposed part F1003711
Concealed part F4020101



F4030101

Concealed body for high flow single lever concealed diverter system consisting of 45 mm cartridge with button Assembly, Cartridge Sleeve (but without operating lever, wall flange and tip ton knob)



F1003531

Single lever sink mixer (wall mounted) with 180 mm (7") long swivel spout, connecting legs and wall flanges



F1003631

Single lever bidet mixer with 450 mm braided connection pipe



F4010101

Concealed body for single lever concealed diverter system consisting of 40 mm cartridge with button Assembly, Cartridge Sleeve (but without operating lever, wall flange and tip ton knob)



Exposed part of high flow single lever concealed diverter with lever, tip ton knob and flange
Exposed part F1003721
Concealed part F4030101



F4060102
F4060101

Concealed body for flush cock consisting of concealed body and cartridge (but without operating lever, cartridge sleeve and wall flange)



Exposed part of flush cock consisting of lever, cartridge sleeve and flange
Exposed part F1003751
Concealed part F4060102
Concealed part F4060101



Exposed part of single lever concealed diverter with lever, tip ton knob and flange
Exposed part F1003701
Concealed part F4010101



F4010105

Concealed body for turn type single lever concealed diverter system consisting of 35 mm cartridge with button Assembly, Cartridge Sleeve (but without operating lever, wall flange and tip ton knob)



Exposed part of turn type single lever concealed diverter with lever, tip ton knob and flange
Exposed part F1003703
Concealed part F4010105

CARBON
SINGLE LEVER / QUARTER TURN RANGE



CARBON SINGLE LEVER / QUARTER TURN RANGE

CERA



F1002101

Pillar cock with aerator



F1002102

Pillar cock with 306 mm (12") long extended body with aerator



F1002151

Bib cock with wall flange and aerator



F1002163

2-Way bib cock with single handle and wall flange



F1002201

Angle cock with wall flange



F1002211

2-Way angle cock with wall flange



F1002251

Sink cock (wall mounted) with 150 mm (6") long swivel spout and wall flange



Concealed part for concealed stop cock suitable for 15 and 20 mm pipeline with inner head (without exposed part)
F4050102 15 mm
F4050103 15 mm
F4050502 20 mm
F4050503 20 mm



Exposed part of stop cock consisting sleeve, lever and flange & concealed part
Exposed part F1002351
Concealed part-15 mm F4050102

Light weight concealed part-15 mm F4050103

Exposed part F1002351
Concealed part-20 mm F4050502

Light weight concealed part-20 mm F4050503

CARBON SINGLE LEVER / QUARTER TURN RANGE

CERA



F1002401

Wall mixer with bend pipe for overhead shower



F1002411

Wall mixer with bend pipe for overhead shower



F1002414

Single lever wall mixer (2-in-1) with telephonic shower arrangement



F1002661

Bath tub spout with wall flange



F1002662

Bath tub spout with wall flange and button arrangement for telephonic shower



F1002631

Single lever bidet mixer with 450 mm braided connection pipe



F1002415

Single lever wall mixer with telephonic shower arrangement only



F1002451

Single lever basin mixer with 450 mm braided connection pipe



F1002471

Wall mounted single lever basin mixer with wall flanges with concealed mixer body



F4010101

Concealed body for single lever concealed diverter system consisting of 40 mm cartridge with button Assembly, Cartridge Sleeve (but without operating lever, wall flange and tip ton knob)



Exposed part F1002701
Concealed part F4010101



F4010105

Concealed body for turn type single lever concealed diverter system consisting of 35 mm cartridge with button Assembly, Cartridge Sleeve (but without operating lever, wall flange and tip ton knob)



F1002531

Single lever sink mixer (wall mounted) with 200 mm (8") long swivel spout, connecting legs and wall flanges



F1002571

Single lever sink mixer (table mounted) with 232 mm (9") long swivel spout and 450 mm long braided connection pipe



F1002651

Wall mounted basin spout and operating lever with wall flanges with concealed single body



Exposed part F1002703
Concealed part F4010105



F4020101

Concealed body for 5-way single lever concealed diverter system consisting of cartridge with button Assembly, Cartridge Sleeve (but without operating lever, wall flange and tip ton knob)



Exposed part F1002711
Concealed part F4020101

CARBON SINGLE LEVER / QUARTER TURN RANGE



F4030101

Concealed body for high flow single lever concealed diverter system consisting of 45 mm cartridge with button Assembly, Cartridge Sleeve (but without operating lever, wall flange and tip ton knob)



Exposed part of high flow single lever concealed diverter with lever, tip ton knob and flange

Exposed part F1002721
Concealed part F4030101



F4060102
F4060101

Concealed body for flush cock consisting of concealed body and cartridge (but without operating lever, cartridge sleeve and wall flange)



Exposed part of flush cock consisting lever, cartridge sleeve and flange

Exposed part F1002751
Concealed part F4060102
Concealed part F4060101

PLATINUM SINGLE LEVER / QUARTER TURN RANGE

CERA



PLATINUM SINGLE LEVER / QUARTER TURN RANGE

CERA



F1001101

Pillar cock with aerator



F1001151

Bib cock with wall flange and aerator



F1001163

2-Way bib cock with single handle and wall flange



F1001451

Single lever basin mixer with 450 mm braided connection pipe (without pop-up)



F1001531

Single lever sink mixer (wall mounted) with 180 mm (7") long swivel spout, connecting legs and wall flanges



F1001561

Single lever sink mixer (table mounted) with swivel spout and pull out hand shower (1 mtr. flexible pipe) with 450 mm braided connection pipe



F1001201

Angle cock with wall flange



F1001211

2-Way angle cock with wall flange

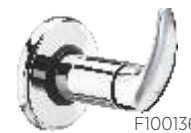

F1001361 15 mm

Concealed stop cock with adjustable wall flange



F1001571

Single lever sink mixer (table mounted) with 232 mm (9") long swivel spout and 450 mm long braided connection pipe



F1001661

Bath tub spout with wall flange



F1001662

Bath tub spout with wall flange and button arrangement for telephonic shower



F1001362 20 mm

Concealed stop cock with adjustable wall flange



F1001411

Wall mixer with bend pipe for overhead shower

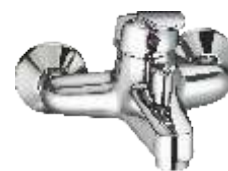

F1001414

Single lever wall mixer (2-in-1) with telephonic shower arrangement



F1001631

Single lever bidet mixer with 450 mm braided connection pipe and provision for pop-up waste system



F4010101

Concealed body for single lever concealed diverter system consisting of 40 mm cartridge with button Assembly, Cartridge Sleeve (but without operating lever, wall flange and tip ton knob)



Exposed part of single lever concealed diverter with lever, tip ton knob and flange
Exposed part F1001701
Concealed part F4010101

PLATINUM SINGLE LEVER / QUARTER TURN RANGE



F4010105

Concealed body for turn type single lever concealed diverter system consisting of 35 mm cartridge with button Assembly, Cartridge Sleeve (but without operating lever, wall flange and tip ton knob)



Exposed part of turn type single lever concealed diverter with lever, tip ton knob and flange
Exposed part F1001703
Concealed part F4010105



F4020101

Concealed body for 5-way single lever concealed diverter system consisting of cartridge with button Assembly, Cartridge Sleeve (but without operating lever, wall flange and tip ton knob)



Exposed part of 5-way single lever concealed diverter with lever, tip ton knob and flange
Exposed part F1001711
Concealed part F4020101



F4030101

Concealed body for high flow single lever concealed diverter system consisting of 45 mm cartridge with button Assembly, Cartridge Sleeve (but without operating lever, wall flange and tip ton knob)



Exposed part of high flow single lever concealed diverter with lever, tip ton knob and flange
Exposed part F1001721
Concealed part F4030101



F4060102
F4060101

Concealed body for flush cock consisting of concealed body and cartridge (but without operating lever, cartridge sleeve and wall flange)



Exposed part of flush cock consisting of lever, cartridge sleeve and flange
Exposed part F1001751
Concealed part F4060102
Concealed part F4060101

VICTOR
SINGLE LEVER / QUARTER TURN RANGE

CERA



VICTOR SINGLE LEVER / QUARTER TURN RANGE

CERA



F1015101

Pillar cock with aerator



F1015102

Pillar cock with 290 mm (11.5") long extended body and aerator



F1015251

Sink cock (wall mounted) with long swivel spout and wall flange



F1015451

Single lever basin mixer with 450 mm braided connection pipe (without pop-up)



F1015452

Single lever basin mixer with 315 mm (12.5") long extended body and 450 mm braided connection pipe (without pop-up)



F1015501

Sink mixer (wall mounted) with 190 mm (7.5") long swivel spout, connecting legs and wall flanges



F1015151

Bib cock with wall flange and aerator



F1015163

2-Way bib cock with single knob and wall flange

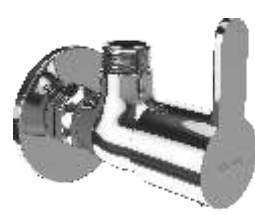

F1015201

Angle cock with wall flange

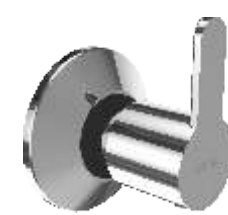

F1015361 15 mm

Concealed stop cock with adjustable wall flange

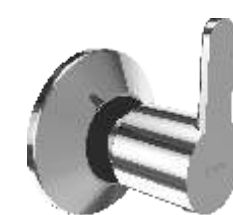

F1015362 20 mm

Concealed stop cock with adjustable wall flange



F4010108

Concealed body for turn type single lever concealed diverter system consisting of 35 mm cartridge with button assembly, Cartridge sleeve (but without operating lever, wall flange and tip ton knob)



F1015661

Bath tub spout with wall flange

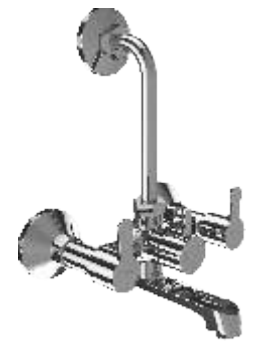

F1015401

Wall mixer with bend pipe for overhead shower

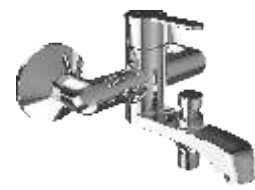

F1015414

Single lever wall mixer with provision for telephonic shower arrangement



Exposed part of single lever concealed diverter with lever, turn type knob, wall flange and concealed part
Exposed part F1015701
Concealed part F4010108



F4060102
F4060101

Concealed body for flush cock consisting of concealed body and cartridge (but without operating lever, cartridge sleeve and wall flange)

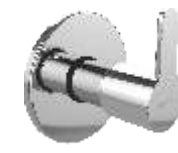

Exposed part of flush cock consisting of lever, cartridge sleeve and flange
Exposed part F1015751
Concealed part F4060102

Concealed part F4060101

DRIVE
QUARTER TURN RANGE



DRIVE QUARTER TURN RANGE

CERA



F2011101
Pillar cock with aerator

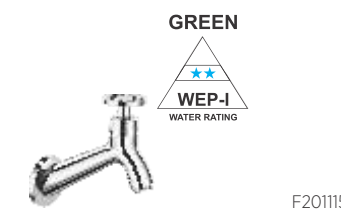

F2011151
Bib cock with wall flange and aerator



F2011201
Angle cock with wall flange



Concealed part for concealed stop cock suitable for 15 and 20 mm pipeline with inner head (without exposed part)
F4050102 15 mm
F4050103 15 mm
F4050502 20 mm
F4050503 20 mm



Exposed part of stop cock consisting sleeve, lever and flange & concealed part
Exposed part F2011351
Concealed part - 15 mm F4050102

Concealed part- 15 mm F4050103

Exposed Part F2011351
Concealed part- 20 mm F4050502

Concealed part- 20 mm F4050503



Wall mixer with bend pipe for overhead shower with built-in non return valve
F2011402

Wall mixer with bend pipe for overhead shower
F2011401



F2011461
Single lever basin mixer with 450 mm braided connection pipe (without pop-up)



F2011261
Sink cock (wall mounted) with 188 mm (7.5") long swivel spout and wall flange



F2011511
Sink mixer (wall mounted) with 185 mm (7.5") long swivel spout, connecting legs and wall flanges

DIVA
QUARTER TURN RANGE



DIVA QUARTER TURN RANGE

CERA



F2010101

Pillar cock with aerator



F2010104 (Left)
F2010105 (Right)

Pillar cock with swan neck
spout (left/right) and aerator



F2010151

Bib cock with wall
flange and aerator



F2010163

2-Way bib cock with single kno B and
wall flange



F2010201

Angle cock
with wall flange



F2010211

2-Way angle cock
with wall flange



F2010251

Sink cock (wall mounted)
with 188 mm (7.5") long
swivel spout and wall flange



F2010301

Sink cock (table mounted)
with 177 mm (7") long
swivel spout



Concealed part for concealed
stop cock suitable for 15 and
20 mm pipeline with inner
head (without exposed part)
F4050102 15 mm
F4050103 15 mm
F4050502 20 mm
F4050503 20 mm

DIVA QUARTER TURN RANGE



Exposed part of stop cock consisting sleeve, lever and flange & concealed part
Exposed part F2010351
Concealed part - 15 mm F4050102

Concealed part- 15 mm F4050103

Exposed Part F2010351

Concealed part- 20 mm F4050502

Concealed part- 20 mm F4050503



Wall mixer with bend pipe for overhead shower with built-in non return valve F2010402

Wall mixer with bend pipe for overhead shower F2010401



F2010403

Wall mixer (3-in-1) with arrangement for both telephonic shower and overhead shower with bend pipe



F2010404

Wall mixer with telephonic shower arrangement



F2010461

Central hole basin mixer with 450 mm braided connection pipe (without pop-up)



F2010501

Sink mixer (wall mounted) with 188 mm (7.5") long swivel spout, connecting legs and wall flanges



F4060101
F4060102

Concealed body for flush cock consisting of concealed body and cartridge (but without operating lever, cartridge sleeve and wall flange)



Exposed part of flush cock consisting lever, cartridge sleeve and flange
Exposed part F2010751
Concealed part F4060101
Concealed part F4060102

DIANA QUARTER TURN RANGE

CERA



DIANA QUARTER TURN RANGE



F2009101

Pillar cock with aerator



F2009103

Pillar cock high neck with aerator



F2009104 (Left)
F2009105 (Right)

Pillar cock with swan neck spout (left/right) and aerator



F2009151

Bib cock with wall flange and aerator



F2009152

Bib cock long nose with wall flange and aerator



F2009163

2-Way bib cock operated with single knob, wall flange



F2009201

Angle cock with wall flange



F2009211

2-Way angle cock with wall flange



F2009251

Sink cock (wall mounted) with 170 mm (6.5") long swivel spout and wall flange



Concealed part for concealed stop cock suitable for 15 and 20 mm pipeline with inner head (without exposed part)
F4050102 15 mm
F4050103 15 mm
F4050502 20 mm
F4050503 20 mm



Exposed part of stop cock consisting sleeve, lever and flange
Exposed part F2009351
Concealed part-15 mm F4050102

Light weight concealed part-15 mm F4050103

Exposed part F2009351
Concealed part-20 mm F4050502

Light weight concealed part-20 mm F4050503



Wall mixer with bend pipe for overhead shower with built-in non return valve
F2009402

Wall mixer with bend pipe for overhead shower
F2009401



F2009403

Wall mixer (3-in-1) with arrangement for both telephonic shower and overhead shower with bend pipe



F2009404

Wall mixer with telephonic shower arrangement



F2009461

Central hole basin mixer with 450 mm braided connection pipe (without pop-up)



F2009501

Sink mixer (wall mounted) with 170 mm (6.5") long swivel spout, connecting legs and wall flanges



F4060101
F4060102

Concealed body for flush cock consisting of concealed body and cartridge (but without operating lever, cartridge sleeve and wall flange)



Exposed part of flush cock consisting lever, cartridge sleeve and flange
Exposed part F2009751
Concealed part F4060101

Concealed part F4060102

CERA

DEW
QUARTER TURN / SINGLE LEVER RANGE



DEW QUARTER TURN / SINGLE LEVER RANGE



F2003101

Pillar cock with aerator



F2003102

Pillar cock with 260 mm
(10.5") long extended
body with aerator



F2003103

Pillar cock high neck
with aerator



F2003104 (Left)
F2003105 (Right)

Pillar cock with swan neck
spout (left/right) and aerator



F2003151

Bib cock with
wall flange and aerator



F2003153

Bib cock with wall flange
and nozzle



F2003163

2-Way bib cock with
single handle and wall flange



F2003201

Angle cock with wall flange



F2003211

2-Way angle cock with
wall flange

DEW QUARTER TURN / SINGLE LEVER RANGE

CERA



F2003251

Sink cock (wall mounted) with 150 mm (6") long swivel spout and wall flange



F2003252

Sink cock (wall mounted) with 150 mm (6") long swivel spout, wall flange and side handle



F2003253

Sink cock (wall mounted) with 150 mm (6") long swivel spout, wall flange and provision for WP connection



F2003405

Wall mixer with spout (no shower arrangement)



F2003451

Single lever basin mixer with 450 mm braided connection pipe (without pop-up)



F2003461

Central hole basin mixer with 450 mm braided connection pipe (without pop-up)



F2003302

Sink cock (table mounted) with 215 mm (8.5") long swivel spout



Concealed part for concealed stop cock suitable for 15 and 20 mm pipeline with inner head (without exposed part)
F4050102 15 mm
F4050103 15 mm
F4050502 20 mm
F4050503 20 mm



Exposed part of stop cock consisting sleeve, lever and flange & concealed part

Exposed part F2003351
Concealed part-15 mm F4050102

Light weight concealed part-15 mm F4050103

Exposed part F2003351
Concealed part-20 mm F4050502

Light weight concealed part-20 mm F4050503



F2003501

Sink mixer (wall mounted) with 150 mm (6") long swivel spout, connecting legs and wall flanges

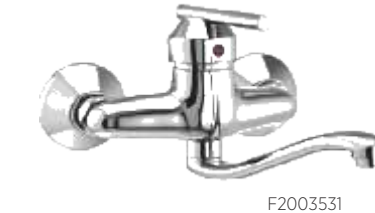

F2003531

Single lever sink mixer (wall mounted) with 180 mm (7") long swivel spout, connecting legs and wall flanges



F2003571

Single lever sink mixer (table mounted) with 232 mm (9") long swivel spout and 450 mm long braided connection pipe



Wall mixer with bend pipe for overhead shower with built-in non return valve
F2003402

Wall mixer with bend pipe for overhead shower
F2003401



F2003403

Wall mixer (3-in-1) with arrangement for both telephonic shower and overhead shower with bend pipe



F2003404

Wall mixer with telephonic shower arrangement



F4010101

Concealed body for single lever concealed diverter system consisting of 40 mm cartridge with button Assembly, Cartridge Sleeve (but without operating lever, wall flange and tip ton knob)



Exposed part F2003701
Concealed part F4010101



F4010105

Concealed body for turn type single lever concealed diverter system consisting of 35 mm cartridge with button Assembly, Cartridge Sleeve (but without operating lever, wall flange and tip ton knob)

DEW QUARTER TURN / SINGLE LEVER RANGE



Exposed part of turn type single lever concealed diverter with lever, tip ton knob and flange
Exposed part F2003703
Concealed part F4010105



F4020101
Concealed body for 5-way single lever concealed diverter system consisting of cartridge with button Assembly, Cartridge Sleeve (but without operating lever, wall flange and tip ton knob)



Exposed part of 5-way single lever concealed diverter with lever, tip ton knob and flange
Exposed part F2003711
Concealed part F4020101



F4030101
Concealed body for high flow single lever concealed diverter system consisting of 45 mm cartridge with button Assembly, Cartridge Sleeve (but without operating lever, wall flange and tip ton knob)



Exposed part of high flow single lever concealed diverter with lever, tip ton knob and flange
Exposed part F2003721
Concealed part F4030101



F4060101
F4060102
Concealed body for flush cock consisting of concealed body and cartridge (but without operating lever, cartridge sleeve and wall flange)



Exposed part of flush cock consisting lever, cartridge sleeve and flange
Exposed part F2003751
Concealed part F4060101
Concealed part F4060102

MIST
QUARTER TURN / SINGLE LEVER RANGE

CERA



MIST QUARTER TURN / SINGLE LEVER RANGE

CERA



F2004101

Pillar cock with aerator



F2004102

Pillar cock with 310 mm (12.5") long extended body with aerator



F2004103

Pillar cock high neck with aerator



F2004251

Sink cock (wall mounted) with 150 mm (6") long swivel spout and wall flange



F2004301

Sink cock (table mounted) with 170 mm (6.5") long swivel spout



F2004302

Single cock goose neck (table mounted) with 215 mm (8.5") long swivel spout



F2004104 (Left)
F2004105 (Right)

Pillar cock with swan neck spout and aerator



F2004151

Bib cock with wall flange and aerator



F2004152

Bib cock long nose with wall flange and aerator



Concealed part for concealed stop cock suitable for 15 and 20 mm pipeline with inner head (without exposed part)
F4050102 15 mm
F4050103 15 mm
F4050502 20 mm
F4050503 20 mm



Exposed part of stop cock consisting sleeve, lever and flange & concealed part

Exposed part F2004351
Concealed part-15 mm F4050102

Light weight concealed part-15 mm F4050103

Exposed part F2004351
Concealed part-20 mm F4050502

Light weight concealed part-20 mm F4050503



Wall mixer with bend pipe for overhead shower with built-in non return valve
F2004402

Wall mixer with bend pipe for overhead shower
F2004401



F2004163

2-Way bib cock with single handle and wall flange



F2004201

Angle cock with wall flange



F2004211

2-Way angle cock with wall flange



F2004403

Wall mixer (3-in-1) with arrangement for both telephonic shower and overhead shower with bend pipe



F2004404

Wall mixer with telephonic shower arrangement



F2004405

Wall mixer with spout (non shower arrangement)

MIST QUARTER TURN / SINGLE LEVER RANGE



F2004414

Single lever wall mixer with telephonic shower arrangement



F2004451

Single lever basin mixer with 450 mm braided connection pipe



F2004461

Central hole basin mixer with 450 mm braided connection pipe (without pop-up)



Exposed part of high flow single lever concealed diverter with lever, tip ton knob and flange

Exposed part F2004721
Concealed part F4030101



F4020101

Concealed body for 5-way single lever concealed diverter system consisting of cartridge with button Assembly, Cartridge Sleeve (but without operating lever, wall flange and tip ton knob)



Exposed part of 5-way single lever concealed diverter with lever, tip ton knob and flange

Exposed part F2004711
Concealed part F4020101



F2004501

Sink mixer (wall mounted) with 150 mm (6") long swivel spout, connecting legs and wall flanges



F4010101

Concealed body for single lever concealed diverter system consisting of 40 mm cartridge with button Assembly, Cartridge Sleeve (but without operating lever, wall flange and tip ton knob)



Exposed part of single lever concealed diverter with lever, tip ton knob and flange

Exposed part F2004701
Concealed part F4010101



F4060101
F4060102

Concealed body for flush cock consisting of concealed body and cartridge (but without operating lever, cartridge sleeve and wall flange)



Exposed part of flush cock consisting of lever, cartridge sleeve and flange & concealed part

Exposed part F2004751
Concealed part F4060101
Concealed part F4060102



F4040101

Concealed body for 4-way single lever concealed diverter system consisting of cartridge with button Assembly, Cartridge Sleeve (but without operating lever, wall flange and knob)



F4010105

Concealed body for turn type single lever concealed diverter system consisting of 35 mm cartridge with button Assembly, Cartridge Sleeve (but without operating lever, wall flange and tip ton knob)



Exposed part of turn type single lever concealed diverter with lever, tip ton knob and flange

Exposed part F2004703
Concealed part F4010105



F4030101

Concealed body for high flow single lever concealed diverter system consisting of 45 mm cartridge with button Assembly, Cartridge Sleeve (but without operating lever, wall flange and tip ton knob)



Exposed part of 4-way single lever concealed diverter with lever, knob and flange

Exposed part F2004731
Concealed part F4040101

CRAYON
QUARTER TURN / SINGLE LEVER RANGE



CRAYON QUARTER TURN / SINGLE LEVER RANGE

CERA

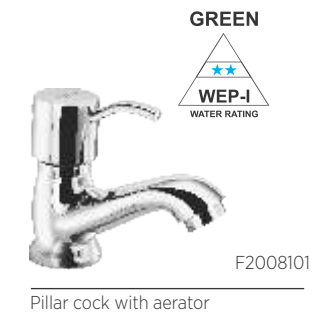

Pillar cock with aerator



Pillar cock with 310 mm (12") long extended body with aerator



Pillar cock high neck with aerator



Pillar cock with swan neck spout (left/right) and aerator



Bib cock with wall flange and aerator

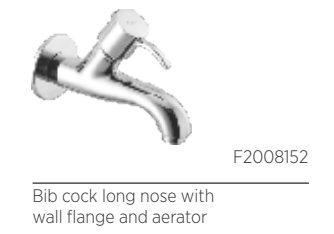

Bib cock long nose with wall flange and aerator



2-Way big cock with single handle and wall flange



Angle cock with wall flange

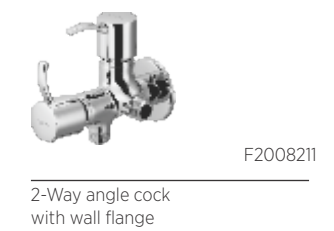

2-Way angle cock with wall flange

CRAYON QUARTER TURN / SINGLE LEVER RANGE

CERA



F2008251

Sink cock (wall mounted) with 170 mm (6.5") long swivel spout and wall flange



Concealed part for concealed stop cock suitable for 15 and 20 mm pipeline with inner head (without exposed part)
 F4050102 15 mm
 F4050103 15 mm
 F4050502 20 mm
 F4050503 20 mm



Exposed part of stop cock consisting sleeve, lever and flange

Exposed part F2008351
 Concealed part-15 mm F4050102

Light weight concealed part-15 mm F4050103

Exposed part F2008351
 Concealed part-20 mm F4050502

Light weight concealed part-20 mm F4050503



F2008571

Single lever sink mixer (table mounted) with 232 mm (9") long swivel spout and 450 mm long braided connection pipe



F4010101

Concealed body for single lever concealed diverter system consisting of 40 mm cartridge with button Assembly, Cartridge Sleeve (but without operating lever, wall flange and tip ton knob)



Exposed part of single lever concealed diverter with lever, tip ton knob and flange

Exposed part F2008701
 Concealed part F4010101



Wall mixer with bend pipe for overhead shower with built-in non return valve
 F2008402

Wall mixer with bend pipe for overhead shower
 F2008401



F2008403

Wall mixer (3-in-1) with arrangement for both telephonic shower and overhead shower with bend pipe



F2008404

Wall mixer with telephonic shower arrangement



F4010105

Concealed body for turn type single lever concealed diverter system consisting of 35 mm cartridge with button Assembly, Cartridge Sleeve (but without operating lever, wall flange and tip ton knob)



Exposed part of turn type single lever concealed diverter with lever, turn type knob and flange

Exposed part F2008703
 Concealed part F4010105



F4060101
 F4060102

Concealed body for flush cock consisting of concealed body and cartridge (but without operating lever, cartridge sleeve and wall flange)



F2008414

Single lever wall mixer with provision for telephonic shower arrangement



F2008461

Central hole basin mixer with 450 mm braided connection pipe (without pop-up)



F2008501

Sink mixer (wall mounted) with 170 mm (6.5") long swivel spout, connecting legs and wall flanges



Exposed part of flush cock consisting lever, cartridge sleeve and flange

Exposed part F2008751
 Concealed part F4060101

Concealed part F4060102

OCEAN
QUARTER TURN/HALF TURN RANGE



OCEAN QUARTER TURN/HALF TURN RANGE



QT F2006101
HT F3001101

Pillar cock with aerator



QT F2006103
HT F3001103

Pillar cock high neck
with aerator



Pillar cock with swan neck
spout (left/right) and aerator
QT F2006104 (Left)
QT F2006105 (Right)
HT F3001104 (Left)
HT F3001105 (Right)



QT F2006151
HT F3001151

Bib cock with wall flange
and aerator



QT F2006152
HT F3001152

Bib cock long nose
with wall flange
and aerator



QT F2006163
HT F3001163

2-Way bib cock with
single knob and wall flange



QT F2006201
HT F3001201

Angle cock with wall flange



QT F2006202
HT F3001202

Angle cock with wall flange (small)



QT F2006211
HT F3001211

2-Way angle cock
with wall flange

OCEAN QUARTER TURN/HALF TURN RANGE



QT F2006251
HT F3001251

Sink cock (wall mounted) with 170 mm (6.5") long swivel spout and wall flange



Concealed part for concealed stop cock suitable for 15 and 20 mm pipeline with inner head (without exposed part)
F4050102 15 mm
F4050103 15 mm
F4050502 20 mm
F4050503 20 mm



Exposed part of stop cock consisting sleeve, lever and flange & concealed part

Exposed part	QT F2006351
Concealed part-15 mm	QT F4050102

Light weight concealed part-15 mm	QT F4050103
Exposed part	QT F2006351
Concealed part-20 mm	QT F4050502

Light weight concealed part-20 mm	QT F4050503
Exposed part	HT F3001351
Concealed part-15 mm	HT F4050102

Light weight concealed part-15 mm	HT F4050103
Exposed part	HT F3001351
Concealed part-20 mm	HT F4050502

Light weight concealed part-20 mm	HT F4050503
-----------------------------------	-------------



Wall mixer with bend pipe for overhead shower with built-in non return valve
QT F2006402
HT F3001402

Wall mixer with bend pipe for overhead shower
QT F2006401
HT F3001401



QT F2006403
HT F3001403

Wall mixer (3-in-1) with arrangement for both telephonic shower and overhead shower with bend pipe



QT F2006404
HT F3001404

Wall mixer with telephonic shower arrangement



QT F2006405
HT F3001405

Wall mixer with spout (non shower arrangement)



QT F2006501
HT F3001501

Sink mixer (wall mounted) with 170 mm (6.5") long swivel spout, connecting legs and wall flanges



QT F2006461
HT F3001461

Central hole basin mixer with 450 mm braided connection pipe (without pop-up)



HT F3001581

Central hole sink mixer (table mounted) with 170 mm (6.5") long swivel spout



F4060101
F4060102

Concealed body for flush cock consisting of concealed body and cartridge (but without operating lever, cartridge sleeve and wall flange)



Exposed part of flush cock consisting lever, cartridge sleeve and flange & concealed part

Exposed part	QT F2006751
Concealed part	QT F4060101

Concealed part	QT F4060102
Exposed part	HT F3001751
Concealed part	HT F4060101

Concealed part	HT F4060102
----------------	-------------

GARNET
QUARTER TURN RANGE



GARNET QUARTER TURN RANGE

CERA



F2002101

Pillar cock with aerator



F2002103

Pillar cock high neck with aerator



F2002104 (Left)
F2002105 (Right)

Pillar cock with swan neck spout (left/right) and aerator



F2002151

Bib cock with wall flange and aerator



F2002152

Bib cock long nose with wall flange and aerator



F2002163

2-way bib cock with single handle and wall flange



F2002201

Angle cock with wall flange



F2002211

2-way angle cock with wall flange



F2002261

Sink cock (wall mounted) with 150 mm (6") long swivel spout and wall flange



F2002361 15 mm

Concealed stop cock with adjustable wall flange



F2002362 20 mm

Concealed stop cock with adjustable wall flange



F2002401

Wall mixer with bend pipe for overhead shower



F2002403

Wall mixer (3-in-1) with arrangement for both telephonic shower and overhead shower with bend pipe



F2002404

Wall mixer with telephonic shower arrangement



F2002405

Wall mixer with spout (non shower arrangement)



F2002461

Central hole basin mixer with 450 mm braided connection pipe (without pop-up)



F2002511

Sink mixer (wall mounted) with 150 mm (6") long swivel spout, connecting legs and wall flanges



F4060101
F4060102

Concealed body for flush cock consisting of concealed body and cartridge (but without operating lever, cartridge sleeve and wall flange)



Exposed part of flush cock consisting lever, cartridge sleeve and flange

Exposed part F2002751
Concealed part F4060101

Concealed part F4060102

FLORAL HALF TURN RANGE

CERA



FLORAL HALF TURN RANGE



F3002101

Pillar cock



F3002103

Pillar cock high neck with aerator



F3002104 (Left)
F3002105 (Right)

Pillar cock with swan neck spout (left/right) and aerator



F3002151

Bib cock



F3002152

Bib cock long body



F3002163

2-Way bib cock with single knob



F3002201

Angle cock



F3002211

2-Way angle cock



F3002261

Sink cock (wall mounted) with 150 mm (6") long swivel spout and aerator



F3002361 15 mm

Concealed stop cock with adjustable wall flange



F3002362 20 mm

Concealed stop cock with adjustable wall flange



F3002401

Wall mixer with bend pipe for overhead shower



F3002403

Wall mixer (3-in-1) with arrangement for both telephonic shower and overhead shower with bend pipe



F3002404

Wall mixer with telephonic shower arrangement



F3002461

Central hole basin mixer with 450 mm braided connection pipe (without pop-up)



F3002511

Sink mixer (wall mounted) with 150 mm (6") long swivel spout, connecting legs and wall flanges



F3002581

Central hole sink mixer (table mounted) with 170 mm (6.5") long swivel spout



F4060101
F4060102

Concealed body for flush cock consisting of concealed body and cartridge (but without operating lever, cartridge sleeve and wall flange)



Exposed part of flush cock consisting of lever, cartridge sleeve and flange

Exposed part F3002751
Concealed part F4060101

Concealed part F4060102

CERA

CONCEALED PARTS

Concealed Part For High Flow Concealed Diverter System



F4030101

Concealed body for high flow single lever concealed diverter system consisting of 45 mm cartridge with button Assembly, Cartridge Sleeve (but without operating lever, wall flange and tip ton knob)
(Suitable for F1002721, F1003721, F2003721, F1001721, F2004721, F1007721, F1008721, F1009721, F1004721, F1005721, F1006721, F1010721, F1011721, F1014712, and F1014721)

Concealed Part For 5-way Concealed Diverter System



F4020101

Concealed body for 5-way single lever concealed diverter system consisting of cartridge with button Assembly, Cartridge Sleeve (but without operating lever, wall flange and tip ton knob)
(Suitable for F1014711, F1014712, F1011711, F1009711, F1005711, F1010711, F1006711, F1007711, F1008711, F1004711, F1003711, F1002711, F1001711, F2003711 and F2004711)

Concealed Part For Single Lever Concealed Diverter System



F4010101

Concealed body for single lever concealed diverter system consisting of 40 mm cartridge with button Assembly, Cartridge Sleeve (but without operating lever, wall flange and tip ton knob)
(Suitable for F1002701, F1003701, F2003701, F1001701, F2004701, F2008701, F1009701, F1008701, F1007701 and F1004701)



F4010103

Concealed body for single lever concealed diverter system consisting of 35 mm cartridge with button Assembly, Cartridge Sleeve (but without operating lever, wall flange and tip ton knob)
(Suitable for F1005701, F1014701 and F1014702)



F4010104

Concealed body for single lever concealed diverter system consisting of 35 mm cartridge with button Assembly, Cartridge Sleeve (but without operating lever, wall flange and tip ton knob)
(Suitable for F1006701, F1010701 and F1011701)

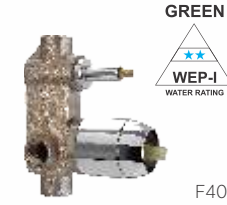

F4010105

Concealed body for turn type single lever concealed diverter system consisting of 35 mm cartridge with button Assembly, Cartridge Sleeve (but without operating lever, wall flange and tip ton knob)
(Suitable for F1007703, F1004703, F1003703, F1002703, F1001703, F2003703, F2004703 and F2008703)

Concealed part for 15 mm concealed stop cock



F4050101

Concealed part for concealed stop cock suitable for 15 mm pipeline with inner head (without exposed parts)
(Suitable for F3001351)



F4050102

Concealed part for concealed stop cock suitable for 15 mm pipeline with inner head (without exposed parts)
(Suitable for F1014351, F1011351, F1009351, F1005351, F1010351, F1006351, F1007351, F1008351, F1004351, F1003351, F1002351, F1001361, F2007351, F2009351, F2003351, F2004351, F2001351, F2008351, F2005361 and F2006351)



F4050103

Concealed part for concealed stop cock light weight suitable for 15 mm pipeline with inner head (without exposed parts)
(Suitable for F1014351, F1011351, F1009351, F1005351, F1010351, F1006351, F1007351, F1008351, F1004351, F1003351, F1002351, F1001361, F2007351, F2009351, F2003351, F2004351, F2001351, F2008351, F2005361 and F2006351)

Concealed part for 20 mm concealed stop cock



F4050501

Concealed part for concealed stop cock suitable for 20 mm pipeline with inner head (without exposed parts)
(Suitable for F3001351)



F4050502

Concealed part for concealed stop cock suitable for 20 mm pipeline with inner head (without exposed parts)
(Suitable for F1014351, F1011351, F1009351, F1005351, F1010351, F1006351, F1007351, F1008351, F1004351, F1003351, F1002351, F1001361, F2007351, F2009351, F2003351, F2004351, F2001351, F2008351, F2005361 and F2006351)



F4050503

Concealed part for concealed stop cock light weight suitable for 20 mm pipeline with inner head (without exposed parts)
(Suitable for F1014351, F1011351, F1009351, F1005351, F1010351, F1006351, F1007351, F1008351, F1004351, F1003351, F1002351, F1001361, F2007351, F2009351, F2003351, F2004351, F2001351, F2008351, F2005361 and F2006351)

Concealed part for flush cocks

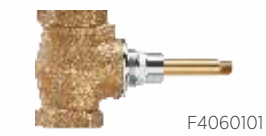

F4060101

Concealed body for flush cock consisting of concealed body and cartridge (but without operating lever, cartridge sleeve and wall flange)
(suitable for F1014751, F1011751, F1009751, F1005751, F1010751, F1006751, F1007703, F1008751, F1004751, F1003751, F1002751, F1001751, F2007751, F2009751, F2003751, F2004751, F2001751, F2008751, F2005751, F2006751, F2002751, F3001751 and F3002751)



F4060102

Concealed body for flush cock consisting of concealed body and cartridge (but without operating lever, cartridge sleeve and wall flange)
(suitable for F1014751, F1011751, F1009751, F1005751, F1010751, F1006751, F1007703, F1008751, F1004751, F1003751, F1002751, F1001751, F2007751, F2009751, F2003751, F2004751, F2001751, F2008751, F2005751, F2006751, F2002751, F3001751 and F3002751)

SINGLE LEVER BASIN MIXER



F9050452

Single lever basin mixer with 320 mm extended body 450 mm braided connection pipe (without pop-up)

SHOWER HAND SHOWER WITH RAIL



F7030451

Hand shower with 3 flow and 1.5 mtr long hose mounted on 360 mm long rail with sliding soap dish

KITCHEN SINK FAUCETS



F1031302

Caabul (Satin SS) Pillar cock with 374 mm (15")



F1032302

Caavi (Satin SS with Green) Pillar cock with 374 mm (15")



F1033302

Caachi (Satin SS with Orange) Pillar cock with 374 mm (15")

TWISTER



F9010101

Pillar cock



F9010102

Pillar cock with extended body



F9010151

Bib cock

CERA

ECO FLOW SHOWERS



F7030501

Hand shower 68 mm dia (2.5") and 132 mm (5.5") long arm



F7030502

Hand shower 120 mm dia (5") and 150 mm (6") long arm



F7020501

Overhead shower 65 mm dia (2.5")



F7020502

Overhead shower 130 mm dia (5") with 3 flow

OVERHEAD RAIN SHOWERS - STAINLESS STEEL



F7010101

Overhead rain shower square 300 x 300 mm (12" x 12")



F7010102

Overhead rain shower square 200 x 200 mm (8" x 8")



F7010103

Overhead rain shower square 250 x 250 mm (10" x 10")



F7010104

Overhead rain shower square 300 x 300 mm (12" x 12")



F7010105

Overhead rain shower square 350 x 350 mm (14" x 14")

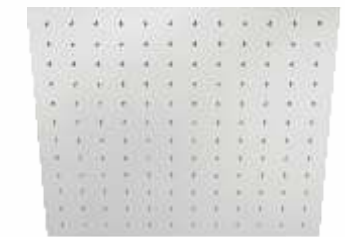

F7010106

Overhead rain shower square 400 x 400 mm (16" x 16")

OVERHEAD RAIN SHOWERS - STAINLESS STEEL

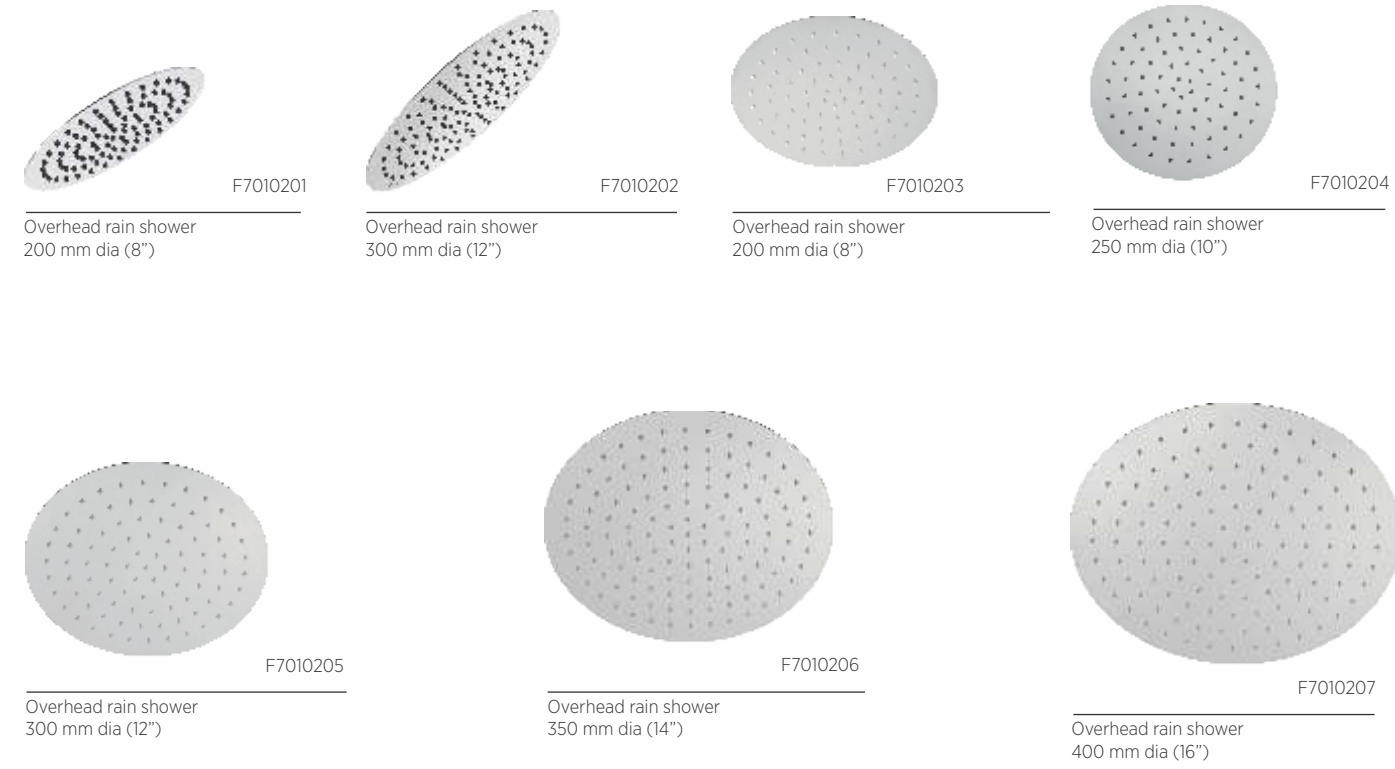

OVERHEAD RAIN SHOWERS - BRASS



OVERHEAD RAIN SHOWERS - ABS



OVERHEAD RAIN SHOWERS - ABS

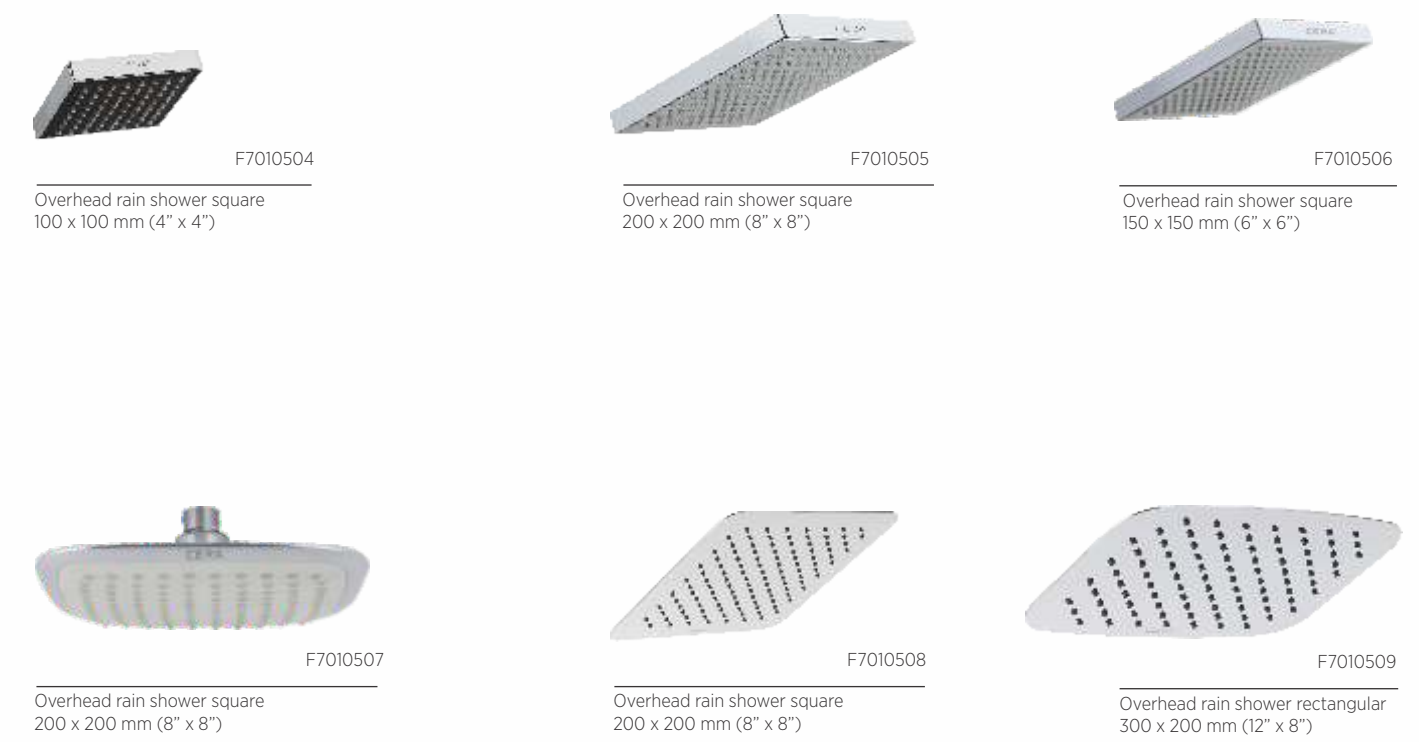

OVERHEAD SHOWERS WITH/WITHOUT ARMS



F7020101

Overhead shower
60 mm (2.5") dia with revolving
joint and shower arm
(suitable for Dew range)



F7020102

Overhead shower 85 mm (3.5") dia
with single flow and shower arm



F7020103

Overhead shower
70 mm (2.5") dia with
235 mm (10.5") long shower arm



F7020104

Overhead shower
70 mm (2.5") dia with shower arm



F7020105

Overhead shower
70 mm (2.5") dia with revolving
joint and shower arm
(suitable for Dew range)



F7020106

Overhead shower
65 mm (2.5") dia with revolving
joint and shower arm
(suitable for Mist range)



F7020301

Overhead shower
80 mm (3") dia with 3 flow



F7020302

Overhead shower
95 mm (4") dia with 3 flow



F7020303

Overhead shower
80 mm (3") dia with 3 flow



F7020304

Overhead shower
95 mm (4") dia with 3 flow



F7020305

Overhead shower
120 mm (5") dia with 3 flow



F7020306

Overhead shower in size
100 x 100 mm (4 x 4")



F7020307

Overhead shower in size
100 x 100 mm (4 x 4")

TELEPHONIC HAND SHOWERS WITH/WITHOUT WALLHOOK AND HOSE

CERA



F7030101

Hand shower in size
100 x 55 mm (4" x 2") with
130 mm (5") long arm



F7030102

Hand shower in size
100 x 55 mm (4" x 2") with
130 mm (5") long arm



F7030103

Hand shower
90 mm (4") dia with 3 flow and
140 mm (5.5") long arm



F7030104

Hand shower
90 mm (4") dia with 3 flow and
140 mm (5.5") long arm



F7030105

Hand shower
90 mm (4") dia with
125 mm (5") long arm



F7030106

Hand shower square in size
66 x 66 mm (2.5 x 2.5") with
3 flow and 135 mm (5.5") long arm



F7030301

Telephonic hand shower
70 mm (3") dia with
wall hook and 1.5 metre hose

SHOWER ARMS STAINLESS STEEL



F7040101

Overhead shower arm
180 mm (7")
with wall flange



F7040102

Overhead shower arm
200 mm (8") with wall flange

SHOWER ARMS - BRASS



F7040103

Overhead shower arm 230 mm (9") with wall flange



F7040104

Overhead shower arm 305 mm (12") with wall flange



F7040105

Overhead shower arm 380 mm (15") with wall flange



F7040106

Overhead shower arm 450 mm (18") with wall flange



F7040201

Overhead shower arm 180 mm (7") with wall flange



F7040202

Overhead shower arm 305 mm (12") with wall flange



F7040203

Overhead shower arm 380 mm (15") with wall flange

BATH TUB SPOUTS WITH/WITHOUT BUTTON ARRANGEMENT



F2001661

Bath tub spout with wall flange (suitable for Dew and Titanium ranges)



F2001662

Bath tub spout with wall flange and button arrangement for telephonic shower (suitable for Dew and Titanium ranges)



F2004661

Bath tub spout with wall flange (suitable for Mist range)



F2004662

Bath tub spout with wall flange and button arrangement for telephonic shower (suitable for Mist range)



F9040101

Pillar cock with spatula lever and aerator

ALLIED PRODUCTS

CERA

FLUSH VALVES



F8010101

Flush valve concealed push type (single flush) 40 mm (1.5")



F8010102

Flush valve concealed push type (single flush) 40 mm (1.5")



F8010103

Flush valve concealed push type (single flush) 32 mm (1.25")



F8010104

Flush valve concealed push type (single flush) 32 mm (1.25")



F8010105

Flush valve concealed push type (dual flush) 32 mm (1.25")



F8010106

Flush valve concealed push type (single flush) 25 mm (1")



F8010107

Flush valve concealed push type (single flush) 25 mm (1")



F8010201

Flush valve concealed push type (dual flush) 40 mm (1.5")



F8010202

Flush valve concealed push type (dual flush) 40 mm (1.5")



F8010203

Flush valve concealed push type (dual flush) 32 mm (1.25")



F8010108

Flush valve concealed push type (single flush) 32 mm (1.25")



F8010301

Flush valve exposed type

CONTROL VALVE



F8015101

Control Valve with knob 25 mm dia

FLUSH COCKS



F2004753

Exposed part for flush cock half turn 25 mm (1") consisting of operating lever, cartridge sleeve and wall flange (suitable for F4060101)



F8020201

Flush cock lever type 25 mm (1")



F8020301

Flush cock push type 25 mm (1")



F8020751

Exposed part for flush cock half turn cross handle 25 mm (1") consisting of operating lever, cartridge sleeve and wall flange (suitable for F4060102)

ANGLE COCKS



F8040201

Angle cock with wall flange



F8040203

Angle cock with wall flange



F8040204

Angle cock with wall flange



F8040205

Angle cock with wall flange

HEALTH FAUCETS

— Set your —
comfort
with Health Faucet.



NEW

F8030401AB
Health Faucet POM with 1.2 metre braided hose pipe

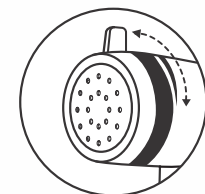

In-built smart pressure regulator in nozzle to adjust flow rate

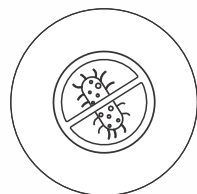

Anti-microbial protection for superior hygiene



Water Efficient Smart design. Saves up to 80% water



Smart touch regulator makes water flow comfortable and does not hurt



Even water flow with an in-built water pressure regulating mechanism that gives uniform and even flow of water



Quality Assured: Made from POM (Delrin) high performance self-lubricating engineering plastic



Simple to install, operate and maintain, with easy-clean, do-it-yourself option for periodic cleaning



Environment friendly with minimal chrome parts



Smooth classic design in subtle colours that complement any bathroom



1.2 Mtr long pipe for ease of reach

HEALTH FAUCETS



F8030101

Health faucet ABS body with wall hook and 1 metre PVC hose pipe



F8030102

Health faucet ABS body with wall hook and 1 metre SS braided rubber hose pipe



F8030103

Health faucet ABS body with wall hook and 1 metre chrome plated PVC hose pipe



F8030202

Health faucet ABS body (push type) with wall hook and 1 metre SS braided rubber hose pipe



F8030301

Health faucet brass body with wall hook and 1 metre SS braided rubber hose pipe



F8030401AB

Health Faucet POM with 1.2 metre braided hose pipe

- In-built smart pressure regulator in nozzle to adjust flow rate
- Anti-microbial protection for superior hygiene

HERA BATH ACCESSORIES



Towel rack 600 mm (24")
F5007101

Towel rack 450 mm (18")
F5007102



Towel rail 600 mm (24")
F5007103

Towel rail 450 mm (18")
F5007104



Towel ring
F5007105



Soap dish
F5007106



Tumbler holder
F5007107

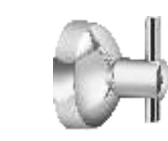

Robe hook
F5007108



Paper holder
F5007109



Paper holder with flap guard
F5007110



Liquid soap dispenser
F5007111

CERA

MONTANA
BATH ACCESSORIES



Towel rack 600 mm (24")
F5002101

Towel rack 450 mm (18")
F5002102



Towel rail 600 mm (24")
F5002103

Towel rail 450 mm (18")
F5002104



F5002105

Towel ring



F5002106

Soap dish



F5002107

Tumbler holder



F5002108

Robe hook



F5002109

Paper holder



F5002110

Paper holder with flap guard



F5002111

Liquid soap dispenser

ORMOND
BATH ACCESSORIES

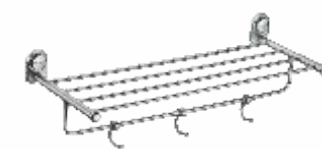

Towel rack 600 mm (24")
F5003101

Towel rack 450 mm (18")
F5003102



Towel rail 600 mm (24")
F5003103

Towel rail 450 mm (18")
F5003104



F5003105

Towel ring



F5003106

Soap dish



F5003107

Tumbler holder



F5003108

Robe hook

CERA



F5003110

Paper holder with flap guard



F5003112

Coat hook 4



F5003113

Coat hook 6

VERMONT
BATH ACCESSORIES



Towel rack 600 mm (24")
F5004101

Towel rack 450 mm (18")
F5004102



Towel rail 600 mm (24")
F5004103

Towel rail 450 mm (18")
F5004104



F5004105

Towel ring



F5004106

Soap dish



F5004107

Tumbler holder



F5004108

Robe hook



F5004109

Paper holder



F5004110

Paper holder with flap guard

OCEANA
BATH ACCESSORIES



F5005101

Corner glass shelf (small)
150 x 150 mm (6" x 6")



F5005102

Corner glass shelf (medium)
225 x 225 mm (9" x 9")



F5005103

Corner glass shelf (large)
300 x 300 mm (12" x 12")

OCEANA
BATH ACCESSORIES

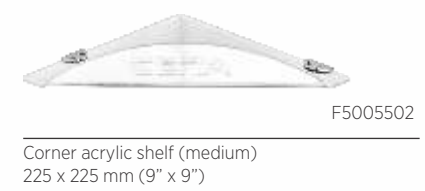
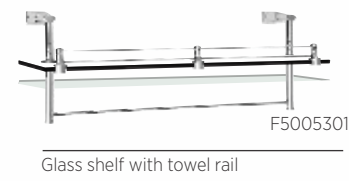
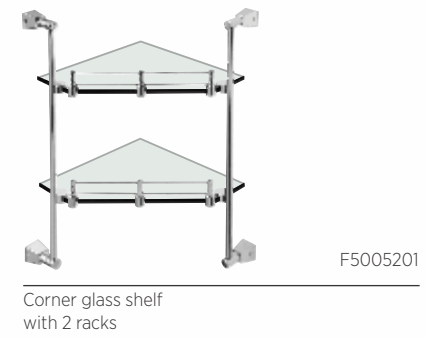

OAKLEY
BATH ACCESSORIES

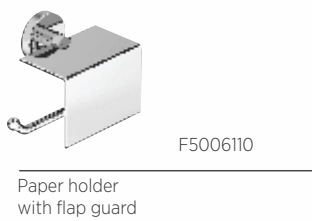
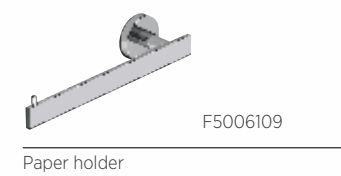
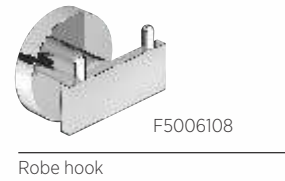
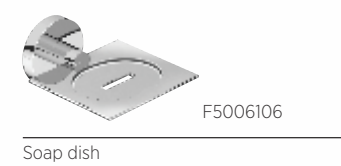
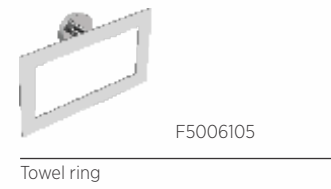
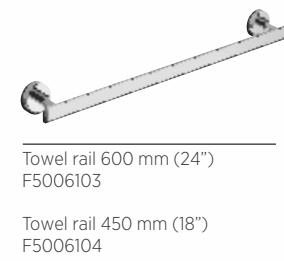
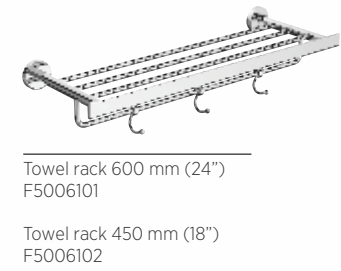

CERA

BATH ACCESSORIES

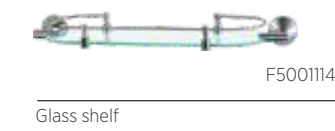
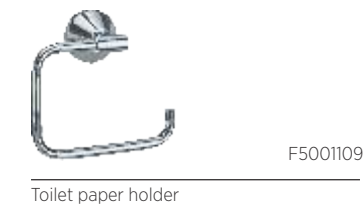
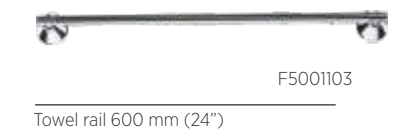
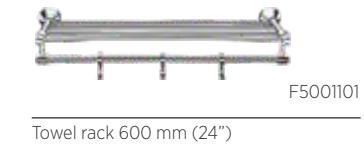

BATH PRODUCTS
AUXILIARIES

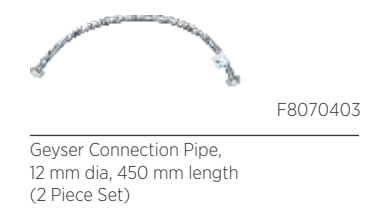
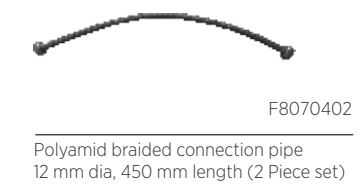

BOTTLE TRAP



F8060101	150 mm (6")
F8060201	178 mm (7")
F8060301	228 mm (9")
F8060302	228 mm (9")
F8060401	300 mm (12")
F8060403	300 mm (12")

AQUAMATIC



F9020101

Pillar cock pressmatic with aerator



F9020151

Bib cock pressmatic with aerator and wall flange



F9020201

Angle cock pressmatic with wall flange



F9020203

Self closing angle cock pressmatic for urinal with wall flange and 200 mm connecting pipe

WASTE COUPLING



F8050101

Waste coupling (full thread) 32 mm



F8050102

Waste coupling (half thread) 32 mm



F8050301

Waste coupling (full thread) 32 mm with 125 mm length



F8050351

Waste coupling with ceramic pop-up push type (full thread) 32 mm



F8050451

Waste coupling pop-up big (full thread)



F8050501

Waste coupling with pop-up for bath tub

CLINICAL



F9030152

Bib cock long body with wall flange and 200 mm lever handle



F9030451

Spactula Single Lever Faucet

CERENA



CERENA
Faucet cleaner 200 ml

Features

- Highly effective lime scale remover.
- Smear on the surface of faucet and wipe after 5 minutes for a new look.
- Safer than conventional cleaners on faucets and other chrome plated bodies.
- Leaves no foul odour after usage.

B2230101

Note:
• Due to continuous upgradations, product specifications may change from time to time. Please verify the actual product for correct specifications before purchase. • Please note that product picture shown and description mentioned alongside might not match in some places. • Coin slot aerator shown in the product pictures is not a part of standard products. • Please see physical product before final selection. Warranty of the product will become null and void if the installation is not done as recommended and/or if not done by qualified technicians. • Whilst every precaution is taken in the compilation of this catalogue, we do not accept responsibility for any error or omission. • All dimensions are in millimetre (nominal). • Sizes mentioned are approximations only. • For exact product size refer to the respective technical drawings.



HANDMADE KITCHEN SINKS

PEARL FINISH KITCHEN SINKS

SATIN FINISH KITCHEN SINKS

CLASSIC RANGE (304 GRADE) KITCHEN SINKS

CLASSIC RANGE (202 GRADE) KITCHEN SINKS

KITCHEN SINK ACCESSORIES

INDEX

OLD CAT. NO.	NEW CAT. NO.	PRODUCT	PAGE NO.
Premium Range - Handmade Double Bowl Sink with Drain Board			
	B4714501	SELENA	160
	B4714502	JAZZ	160
Premium Range - Handmade Double Bowl Sink			
	B4713501	ROSA	160
	B4713502	TITO	160
Premium Range - Handmade Single Bowl Sink with Drain Board			
	B4712501	LEAH	160
	B4712502	NOVA	160
Premium Range - Handmade Single Bowl Sink			
	B4711503	ELENA	161
	B4711504	REMY	161
	B4711505	JASON	161
Pearl Finish - Double Bowl Sink with Drain Board			
	B4724501	NAOMI	163
Pearl Finish - Double Bowl Sink			
	B4723501	TYSON	163
Pearl Finish - Single Bowl Sink with Drain Board			
	B4722501	DOLLY	163
	B4722502	BELLA	163
	B4722503	LEON	163
Pearl Finish - Single Bowl Sink			
	B4721501	SILA	163
Satin Finish - Double Bowl Sink with Drain Board			
	B4724503	NICO	165
	B4724502	FALCON	165
	B4723502	ZION	165
Satin Finish - Single Bowl Sink with Drain Board			
	B4722504	BRADY	165
Satin Finish - Single Bowl Sink			
	B4711501	ALMA	165
	B4711502	ATLAS	165
Premium Range - Single bowl sinks with drain board			
CKSP 311	B4722402	CONWAY	165
CKSP 411	B4722403	COLINA	165
Classic Range - Double bowl sinks with drain board			
NCKS 314	B4514201	JUMBO	167
NCKS 316	B4514202	SUPER JUMBO	167
Classic Range - Double bowl sinks			
NCKS 311	B4513201	KING	167
NCKS 312A	B4513202	DELUXE	167
NCKS 312	B4513203	DELUXE	167
NCKS 313	B4513204	OPUS	167

OLD CAT. NO.	NEW CAT. NO.	PRODUCT	PAGE NO.
Classic Range - Single bowl sinks with drain board			
NCKS 211A	B4512201	CELEBRITY	167
NCKS 211B	B4512202	CELEBRITY JUNIOR	167
NCKS 212	B4512203	PRINCE	167
NCKS 213A	B4512205	JUMBO	168
NCKS 213	B4512204	JUMBO	168
KCG 1011	B4512101	DIANA	168
KCG 1012	B4512102	DAKOTA	168
Classic Range - Single bowl sinks			
KCG 1001	B4511101	DALLAS	168
KCG 1002	B4511102	DARBY	168
KCG 1003	B4511103	DOMINO	168
KCG 1004	B4511104	DORA	168
KCG 1005	B4511105	DREW	168
NCKS 111A	B4511201	QUEEN	168
NCKS 111	B4511202	QUEEN	168
NCKS 112	B4511203	DAISY	169
NCKS 113	B4511204	LILAC	169
NCKS 115	B4511205	MAPLE	169
NCKS 116A	B4511207	COSSET	169
NCKS 116	B4511206	COSSET	169
202 Grade Pearl Finish - Single Bowl Sink with Drain Board			
	B4922501	DOLLY	170
202 Grade Pearl Finish - Single Bowl Sink			
	B4921501	SILA	170
Classic Range - 202 Grade			
KLK 1011	B4622101	DIANA LITE	170
KLK 1012	B4622102	DAKOTA LITE	170
KLK 1001	B4621101	DALLAS LITE	170
KLK 1002	B4621102	DARBY LITE	170
KLK 1003	B4621103	DOMINO LITE	170
KLK 1004	B4621104	DORA LITE	171
KLK 1005	B4621105	DREW LITE	171



HANDMADE KITCHEN SINKS

HANDMADE DOUBLE BOWL SINKS WITH DRAIN BOARD



SELENA
Handmade double bowl sink with drain board
304 grade stainless steel
Size: 1000 x 500 mm (40" x 20")
Bowl Size: 380 x 450 mm (15" x 18") and
250 x 450 mm (10" x 18")
Depth: 200 mm (8")
Installation: Undermount
Cat. No. B4714501 - Satin finish



JAZZ
Handmade double bowl sink with drain board
304 grade stainless steel
Size: 1210 x 510 mm (48" x 20")
Bowl Size: 480 x 460 mm (19" x 18") and
300 x 460 mm (12" x 18")
Depth: 230 mm (9")
Installation: Undermount
Cat. No. B4714502 - Satin finish

HANDMADE DOUBLE BOWL SINKS



ROSA
Handmade double bowl sink
304 grade stainless steel
Size: 925 x 450 mm (37" x 18")
Bowl Size: 425 x 400 mm (17" x 16") and
425 x 400 mm (17" x 16")
Depth: 200 mm (8")
Installation: Undermount
Cat. No. B4713501 - Satin finish



TITO
Handmade double bowl sink
304 grade stainless steel
Size: 1125 x 500 mm (45" x 20")
Bowl Size: 525 x 450 mm (21" x 18") and
525 x 450 mm (21" x 18")
Depth: 250 mm (10")
Installation: Undermount
Cat. No. B4713502 - Satin finish

HANDMADE SINGLE BOWL SINKS WITH DRAIN BOARD



LEAH
Handmade single bowl sink with drain board
304 grade stainless steel
Size: 860 x 450 mm (34" x 18")
Bowl Size: 450 x 400 mm (18" x 16")
Depth: 200 mm (8")
Installation: Undermount
Cat. No. B4712501 - Satin finish



NOVA
Handmade single bowl sink with drain board
304 grade stainless steel
Size: 1000 x 500 mm (40" x 20")
Bowl Size: 500 x 450 mm (20" x 18")
Depth: 230 mm (9")
Installation: Undermount
Cat. No. B4712502 - Satin finish

HANDMADE SINGLE BOWL SINKS



ELENA
Handmade single bowl sink
304 grade stainless steel
Size: 455 x 405 mm (18" x 16")
Bowl Size: 405 x 355 mm (16" x 14")
Depth: 230 mm (9")
Installation: Undermount
Cat. No. B4711503 - Satin finish



REMY
Handmade single bowl sink
304 grade stainless steel
Size: 510 x 430 mm (20" x 17")
Bowl Size: 460 x 380 mm (18" x 15")
Depth: 230 mm (9")
Installation: Undermount
Cat. No. B4711504 - Satin finish



JASON
Handmade single bowl sink
304 grade stainless steel
Size: 610 x 455 mm (24" x 18")
Bowl Size: 562 x 407 mm (22" x 16")
Depth: 230 mm (9")
Installation: Undermount
Cat. No. B4711505 - Satin finish

DOUBLE BOWL SINK WITH DRAIN BOARD



NAOMI
 Double bowl sink with drain board and waste bin
 304 grade stainless steel
 Size: 1200 x 500 mm (48" x 20")
 Bowl Size: 385 x 400 mm (15" x 16") and
 385 x 400 mm (15" x 16")
 Depth: 230 mm (9")
 Installation: Over-mount
 Cat. No. B4724501 - Pearl finish

DOUBLE BOWL SINK



TYSON
 Double bowl sink
 304 grade stainless steel
 Size: 980 x 480 mm (39" x 19")
 Bowl Size: 400 x 400 mm (16" x 16") and
 400 x 400 mm (16" x 16")
 Depth: 230 mm (9")
 Installation: Over-mount
 Cat. No. B4723501 - Pearl finish

SINGLE BOWL SINKS WITH DRAIN BOARD

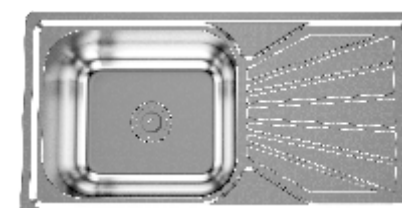

DOLLY
 Single bowl sink with drain board
 304 grade stainless steel
 Size: 780 x 410 mm (31" x 16")
 Bowl Size: 380 x 330 mm (15" x 13")
 Depth: 210 mm (8")
 Installation: Over-mount
 Cat. No. B4722501 - Pearl finish



BELLA
 Single bowl sink with drain board
 304 grade stainless steel
 Size: 780 x 410 mm (31" x 16")
 Bowl Size: 380 x 330 mm (15" x 13")
 Depth: 210 mm (8")
 Installation: Over-mount
 Cat. No. B4722502 - Pearl finish



LEON
 Single bowl sink with drain board
 304 grade stainless steel
 Size: 900 x 500 mm (39" x 20")
 Bowl Size: 385 x 410 mm (15" x 16")
 Depth: 230 mm (9")
 Installation: Over-mount
 Cat. No. B4722503 - Pearl finish

SINGLE BOWL SINK



SILA
 Single bowl sink
 304 grade stainless steel
 Size: 600 x 445 mm (24" x 18")
 Bowl Size: 500 x 345 mm (21" x 14")
 Depth: 210 mm (8")
 Installation: Over-mount
 Cat. No. B4721501 - Pearl finish



PEARL FINISH



SATIN FINISH

CERA

DOUBLE BOWL SINKS WITH DRAIN BOARD



NICO
 Double bowl corner sink with drain board
 304 grade stainless steel
 Size: 900 x 900 mm (36" x 36")
 Bowl Size: 400 x 350 mm (16" x 14") and
 400 x 350 mm (16" x 14")
 Depth: 210 mm (8")
 Installation: Over-mount
 Cat. No. B4724503 - Satin Finish



FALCON
 Double bowl sink with drain board and waste bin
 304 grade stainless steel
 Size: 1100 x 500 mm (44" x 20")
 Bowl Size: 400 x 400 mm (16" x 16") and
 275 x 325 mm (11" x 13")
 Depth: 230 mm (9")
 Installation: Over-mount
 Cat. No. B4724502 - Satin Finish



ZION
 Double bowl sink with waste bin
 304 grade stainless steel
 Size: 885 x 410 mm (35" x 16")
 Bowl Size: 325 x 325 mm (13" x 13") and
 300 x 280 mm (12" x 11")
 Depth: 185 mm (7")
 Installation: Over-mount
 Cat. No. B4723502 - Satin Finish

SINGLE BOWL SINKS WITH DRAIN BOARD



BRADY
 Single bowl sink with drain board and waste bin
 304 grade stainless steel
 Size: 680 x 400 mm (27" x 16")
 Bowl Size: 400 x 320 mm (16" x 13")
 Depth: 180 mm (7")
 Installation: Over-mount
 Cat. No. B4722504 - Satin finish



CONWAY
 Single bowl sink manufactured from
 0.8 mm thick 304 grade stainless steel
 Size: 680 x 450 mm (26.75" x 17.75")
 Cut-out dimension: 660 x 430 mm (26" x 17")
 Depth: 192 mm (7.6")
 Installation: Top mount with installation clips
 Cat. No. B4722402 - Satin finish



COLINA
 Single bowl sink manufactured from
 0.8 mm thick 304 grade stainless steel
 Size: 900 x 470 mm (35.5" x 18.5")
 Cut-out dimension: 874 x 444 mm (34.4" x 17.5")
 Depth: 195 mm (7.7")
 Installation: Top mount with installation clips
 Cat. No. B4722403 - Satin finish

SINGLE BOWL SINKS



ALMA
 Single bowl sink
 304 grade stainless steel
 Size: 590 x 460 mm (23" x 18")
 Bowl Size: 540 x 410 mm (21" x 16")
 Depth: 230 mm (9")
 Installation: Undermount
 Cat. No. B4711501 - Satin finish



ATLAS
 Single bowl sink
 304 grade stainless steel
 Size: 765 x 465 mm (30" x 18")
 Bowl Size: 715 x 415 mm (28" x 16")
 Depth: 230 mm (9")
 Installation: Undermount
 Cat. No. B4711502 - Satin finish



CLASSIC RANGE

CERA

**CLASSIC RANGE
DOUBLE BOWL SINKS WITH DRAIN BOARD**



JUMBO
Double bowl sink manufactured from 1.0 mm thick 304 grade stainless steel
Size: 1156 x 533 mm (45.5" x 20.5")
Depth: 205 mm (8")
Installation: Top mount
Cat. No. B4514201 - Gloss finish
Cat. No. B4514201 - Matt finish



SUPER JUMBO
Double bowl sink manufactured from 1.0 mm thick 304 grade stainless steel
Size: 1210 x 510 mm (48" x 20")
Depth: 200 mm (8")
Installation: Top mount
Cat. No. B4514202 - Gloss finish
Cat. No. B4514202 - Matt finish

DOUBLE BOWL SINKS



KING
Double bowl sink manufactured from 1.0 mm thick 304 grade stainless steel
Size: 940 x 490 mm (37" x 19.25")
Depth: 205 mm (8")
Installation: Top mount
Cat. No. B4513201 - Gloss finish
Cat. No. B4513201 - Matt finish



DELUX
Double bowl sink manufactured from 1.0 mm thick 304 grade stainless steel
Size: 1155 x 515 mm (45.5" x 20.5")
Installation: Top mount
Depth: 205 mm (8")
Cat. No. B4513202 - Gloss finish
Cat. No. B4513202 - Matt finish
Depth: 250 mm (10")
Cat. No. B4513203 - Gloss finish
Cat. No. B4513203 - Matt finish



OPUS
Double bowl sink manufactured from 1.0 mm thick 304 grade stainless steel
Size: 1000 x 510 mm (40" x 20")
Depth: 205 mm (8")
Installation: Top mount
Cat. No. B4513204 - Gloss finish
Cat. No. B4513204 - Matt finish

SINGLE BOWL SINKS WITH DRAIN BOARD



CELEBRITY
Single bowl sink manufactured from 1.0 mm thick 304 grade stainless steel
Size: 940 x 465 mm (37" x 18")
Depth: 205 mm (8")
Installation: Top mount
Cat. No. B4512201 - Gloss finish
Cat. No. B4512201 - Matt finish



CELEBRITY JUNIOR
Single bowl sink manufactured from 1.0 mm thick 304 grade stainless steel
Size: 810 x 455 mm (32" x 18")
Depth: 205 mm (8")
Installation: Top mount
Cat. No. B4512202 - Gloss finish
Cat. No. B4512202 - Matt finish



PRINCE
Single bowl sink manufactured from 1.0 mm thick 304 grade stainless steel
Size: 1040 x 500 mm (41" x 20")
Depth: 205 mm (8")
Installation: Top mount
Cat. No. B4512203 - Gloss finish
Cat. No. B4512203 - Matt finish

SINGLE BOWL SINKS WITH DRAIN BOARD



JUMBO
Single bowl sink manufactured from 1.0 mm thick 304 grade stainless steel
Size: 1155 x 515 mm (45.5" x 20.5")
Installation: Top mount

Depth: 205 mm (8")

Cat. No. B4512204 - Gloss finish
Cat. No. B4512204 - Matt finish

Depth: 250 mm (10")

Cat. No. B4512205 - Gloss finish
Cat. No. B4512205 - Matt finish



DIANA
Single bowl sink manufactured from 1.0 mm thick 304 grade stainless steel
Size: 940 x 455 mm (37" x 18")
Depth: 203 mm (8")
Installation: Top mount
Cat. No. B4512101 - Gloss finish
Cat. No. B4512101 - Matt finish



DAKOTA
Single bowl sink manufactured from 1.0 mm thick 304 grade stainless steel
Size: 810 x 455 mm (32" x 18")
Depth: 203 mm (8")
Installation: Top mount
Cat. No. B4512102 - Gloss finish
Cat. No. B4512102 - Matt finish

SINGLE BOWL SINKS



DALLAS
Single bowl sink manufactured from 1.0 mm thick 304 grade stainless steel
Size: 610 x 455 mm (24" x 18")
Depth: 255 mm (10")
Installation: Top mount

Cat. No. B4511101 - Gloss finish
Cat. No. B4511101 - Matt finish



DARBY
Single bowl sink manufactured from 1.0 mm thick 304 grade stainless steel
Size: 610 x 455 mm (24" x 18")
Depth: 203 mm (8")
Installation: Top mount

Cat. No. B4511102 - Gloss finish
Cat. No. B4511102 - Matt finish



DOMINO
Single bowl sink manufactured from 1.0 mm thick 304 grade stainless steel
Size: 535 x 455 mm (21" x 18")
Depth: 203 mm (8")
Installation: Top mount

Cat. No. B4511103 - Gloss finish
Cat. No. B4511103 - Matt finish



DORA
Single bowl sink manufactured from 1.0 mm thick 304 grade stainless steel
Size: 510 x 430 mm (20" x 17")
Depth: 203 mm (8")
Installation: Top mount

Cat. No. B4511104 - Gloss finish
Cat. No. B4511104 - Matt finish



DREW
Single bowl sink manufactured from 1.0 mm thick 304 grade stainless steel
Size: 455 x 405 mm (18" x 16")
Depth: 203 mm (8")
Installation: Top mount

Cat. No. B4511105 - Gloss finish
Cat. No. B4511105 - Matt finish



QUEEN
Single bowl sink manufactured from 1.0 mm thick 304 grade stainless steel
Size: 610 x 460 mm (24" x 18")
Installation: Top mount

Depth: 205 mm (8")

Cat. No. B4511201 - Gloss finish
Cat. No. B4511201 - Matt finish

Depth: 250 mm (10")

Cat. No. B4511202 - Gloss finish
Cat. No. B4511202 - Matt finish



DAISY
Single bowl sink manufactured from 1.0 mm thick 304 grade stainless steel
Size: 460 x 405 mm (18" x 16")
Depth: 180 mm (7")
Installation: Top mount

Cat. No. B4511203 - Gloss finish
Cat. No. B4511203 - Matt finish



LILAC
Single bowl sink manufactured from 1.0 mm thick 304 grade stainless steel
Size: 510 x 430 mm (20" x 17")
Depth: 205 mm (8")
Installation: Top mount

Cat. No. B4511204 - Gloss finish
Cat. No. B4511204 - Matt finish



MAPLE
Single bowl sink manufactured from 1.0 mm thick 304 grade stainless steel
Size: 535 x 460 mm (21" x 18")
Depth: 205 mm (8")
Installation: Top mount

Cat. No. B4511205 - Gloss finish
Cat. No. B4511205 - Matt finish



COSSET
Single bowl sink manufactured from 1.0 mm thick 304 grade stainless steel
Size: 600 x 500 mm (24" x 20")
Installation: Top mount

Depth: 205 mm (8")

Cat. No. B4511206 - Gloss finish
Cat. No. B4511206 - Matt finish

Depth: 255 mm (10")

Cat. No. B4511207 - Gloss finish
Cat. No. B4511207 - Matt finish

Notes: - Due to continuous upgradations, product specifications may change from time to time. Please verify the actual product for correct specifications before purchase. Please see physical product before final selection. - Cera sinks have a limited life time warranty against material and workmanship defects. - The warranty does not include all incidental or consequential damages, labour charges for installation and replacement and associated material. This warranty also does not include any dents or scratches due to any kind of negligence. - Whilst every precaution has been taken in the compilation of the catalogue, we do not accept responsibility for any error or omission. - The designs are subject to change without prior notice. - All dimensions are in millimetre (nominal), ±5 mm variations to be considered. - Sizes mentioned are approximations only. - For exact product size refer to the respective technical drawings.

202 GRADE STAINLESS STEEL - PEARL FINISH
SINGLE BOWL SINK WITH DRAIN BOARD

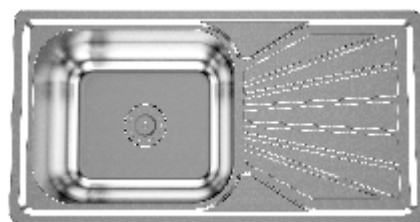

DOLLY
Single bowl sink with drain board
202 grade stainless steel
Size: 780 x 410 mm (31" x 16")
Bowl Size: 380 x 330 mm (15" x 13")
Depth: 210 mm (8")
Installation: Over-mount
Cat. No. B4922501 - Pearl finish

SINGLE BOWL SINK



SILA
Single bowl sink
202 grade stainless steel
Size: 600 x 445 mm (24" x 18")
Bowl Size: 500 x 345 mm (20" x 14")
Depth: 210 mm (8")
Installation: Over-mount
Cat. No. B4921501 - Pearl finish

202 GRADE STAINLESS STEEL - CLASSIC RANGE
SINGLE BOWL SINKS WITH DRAIN BOARD



DIANA LITE
Single bowl sink manufactured from 0.8 mm thick 202 grade stainless steel
Size: 940 x 455 mm (37" x 18")
Depth: 203 mm (8")
Installation: Top mount
Cat. No. B4622101 - Gloss finish
Cat. No. B4622101 - Matt finish



DAKOTA LITE
Single bowl sink manufactured from 0.8 mm thick 202 grade stainless steel
Size: 810 x 455 mm (32" x 18")
Depth: 203 mm (8")
Installation: Top mount
Cat. No. B4622102 - Gloss finish
Cat. No. B4622102 - Matt finish

SINGLE BOWL SINKS



DALLAS LITE
Single bowl sink manufactured from 0.8 mm thick 202 grade stainless steel
Size: 610 x 455 mm (24" x 18")
Depth: 255 mm (10")
Installation: Top mount
Cat. No. B4621101 - Gloss finish
Cat. No. B4621101 - Matt finish



DARBY LITE
Single bowl sink manufactured from 0.8 mm thick 202 grade stainless steel
Size: 610 x 455 mm (24" x 18")
Depth: 203 mm (8")
Installation: Top mount
Cat. No. B4621102 - Gloss finish
Cat. No. B4621102 - Matt finish



DOMINO LITE
Single bowl sink manufactured from 0.8 mm thick 202 grade stainless steel
Size: 535 x 455 mm (21" x 18")
Depth: 203 mm (8")
Installation: Top mount
Cat. No. B4621103 - Gloss finish
Cat. No. B4621103 - Matt finish

SINGLE BOWL SINK



DORA LITE
Single bowl sink manufactured from 0.8 mm thick 202 grade stainless steel
Size: 510 x 430 mm (20" x 17")
Depth: 203 mm (8")
Installation: Top mount
Cat. No. B4621104 - Gloss finish
Cat. No. B4621104 - Matt finish



DREW LITE
Single bowl sink manufactured from 0.8 mm thick 202 grade stainless steel
Size: 455 x 405 mm (18" x 16")
Depth: 203 mm (8")
Installation: Top mount
Cat. No. B4621105 - Gloss finish
Cat. No. B4621105 - Matt finish

KITCHEN SINK ACCESSORIES 304 GRADE STAINLESS STEEL



B4811501

Outlet connection pipe for double bowl sink without overflow



B4811502

Outlet connection pipe for double bowl sink with overflow (Only for B4724501, B4724502 and B4724503)



B4811503

Outlet connection pipe for single bowl sink without overflow



B4811504

Outlet connection pipe for single bowl sink with overflow (Only for B4722504)



B4811511 (304 grade)

Round strainer 110 mm dia



B4811513 (304 grade)

Square strainer 110 x 110 mm

202 GRADE STAINLESS STEEL



B4811512 (202 grade)

Round strainer 110 mm dia

Notes: Kitchen sinks 202 grade stainless steel sinks have a limited life time warranty against material and workmanship defects, have 1 year warranty for residential installation & 6 months warranty for commercial installation against any manufacturing defect.

WELLNESS

CERA
Wellness



INDEX

OLD CAT. NO.	NEW CAT. NO.	NAME	PAGE NO.
Customised Shower Partitions			
Customised shower partitions			175
Steam shower rooms			
8721	B2513101	CUPID	176
8752	B2513104	CANDRA	176
8711	B2514101	CZARINA	176
8712	B2514102	CZAR	176
8713	B2514103	CUBIT	176
	B2513112	CANYON	177
	B2513113	CADEO	177
	B2513114	CAMIKA	177
Shower cubicles			
8811	B2511101	CUBA	178
8821	B2511103	COCOON	178
8851	B2511104	CIGMA	178
	B2511110	CABRINI	152
Shower Partition			
8841C	B2510103	CADET	178
8843A	B2510107	COLTEN	178
8843B	B2510108	COLTEN	178
	B2510112	CADMAX	179
	B2510113	CADMID	179
	B2510114	CADMIN	179
	B2510115	CARMAX	179
	B2510116	CARMID	179
	B2510117	CADMEGA	179
Bath tubs with whirlpool			
8012	B2524101	COLLEEN	187
8020	B2524103	CAMERON	187
	B2524105	CABUSA	180
	B2524106	CAHIRA	180
	B2524107	CAITIE	180
	B2524108	CALEN	180
Bath tubs			
8001	B2520101	CAROL	181
8101	B2521101	FRONT PANEL	181
8201	B2521104	SIDE PANEL	181
8301	B2522101	SUPPORTING STRUCTURE	181
8002	B2520102	CERATON	181
8101	B2521101	FRONT PANEL	181
8201	B2521104	SIDE PANEL	181
8301	B2522101	SUPPORTING STRUCTURE	181
8003	B2520103	CORNER	181
8103	B2521102	CORNER PANEL	181
8303	B2522102	SUPPORTING STRUCTURE	181
8005	B2520104	CITADEL	181
8105	B2521103	FRONT PANEL	181
8205	B2521105	SIDE PANEL	181
8305	B2522103	SUPPORTING STRUCTURE	181
8006*	B2520105	CONY	181
8006	B2520106	CONY	181
Shower trays			
8004	B2512101	CORNER TRAY	181
8004A	B2512102	SQUARE TRAY	181
Shower panels			
8950AB	B2530102	CORAL	181
8950SB	B2530101	CORAL PREMIUM	181
8951ATB	B2530104	CYRPUK PREMIUM	181
8952ATB	B2530106	CONRAL PREMIUM	181

OLD CAT. NO.	NEW CAT. NO.	NAME	PAGE NO.
Shower panels			
8953SB	B2530107	CONWAY	182
8954SB	B2530109	CASTOR	182
8955RB	B2530111	CHANE	183
8956SB	B2530114	CHARIS	183
8957RB	B2530115	CHAVA	183
Pressure pump			
8614	B2540101	CRYPTON LITE	183
8614A	B2541101	CRYPTON TANK	183
8615	B2540102	CRYPTON SUPER	183
8614A	B2541101	CRYPTON TANK	183

CUSTOMISED SHOWER PARTITIONS

Customised shower partitions to suit any size.
Made to measure as per the size.



Two panels and one door in middle

Wall to wall customised shower partition with two glasses fixed on both sides and one door in the centre

Size : 1,950 mm height x customised width
Glass : 8 mm or 10 mm tempered glass
Door handle : Choose from 3 elegant designs



One panel and one door

Wall to wall customised shower partition with one fixed glass and one door

Size : 1,950 mm height x customised width
Glass : 8 mm or 10 mm tempered glass
Door handle : Choose from 3 elegant designs



Single door

Wall to wall customised shower partition with one fixed glass door

Size : 1,950 mm height x customised width
Glass : 8 mm or 10 mm tempered glass
Door handle : Choose from 3 elegant designs



L-shaped partition – Cubicle

Wall fixed (L-shaped partition) cubicle with one fixed glass partition on one side and one fixed glass partition & one door on the second side

Size : 1,950 mm height x customised width
Glass : 8 mm or 10 mm tempered glass
Door handle : Choose from 3 elegant designs

STEAM SHOWER ROOMS



CUPID
 Steam Shower Room
 1030 x 1030 x 2200 mm

- Shower room with steam generator and ventilator
- Six water jets for back and body massage
- Foot massage
- Hand shower and overhead rain shower
- Hot & cold mixer and diverter
- Pleasant mood-elevating lights
- Mirror with shampoo holder and towel rack
- Steam cleaning function
- FM Radio
- Multi functional electronic panel

Cat. No. B2513101



CANDRA
 Steam Shower Room
 1000 x 1000 x 2260 mm

- Shower room with steam generator and ventilator
- Six water jets for back and body massage
- Hand shower and overhead rain shower
- Hot & cold mixer and diverter
- Pleasant mood-elevating lights
- Shampoo holder and towel rack
- Steam cleaning function
- FM Radio
- Touch screen F8 control panel
- 100% drainable shower tray
- Super smooth and quiet sliding door

Cat. No. B2513104



CZARINA
 Steam Shower Room
 1320 x 1320 x 2200 mm

- Whirlpool bathtub for two people
- Shower room with steam generator and ventilator
- Six water jets for back and body massage
- Foot massage
- Hand shower and overhead rain shower
- Hot & cold mixer and diverter
- Pleasant mood-elevating lights
- Mirror with shampoo holder and towel rack
- Steam cleaning function
- FM Radio
- Telephone to take calls
- Multi functional electronic panel

Cat. No. B2514101



CANYON
 Steam Shower Room
 1000 x 1000 x 2200 mm

- Ceiling Shower gives rain shower experience
- Hand Shower
- Top and back lamps provide bathroom like ambience
- Back massage jets gently soothe and invigorate body
- Control panel to operate all functions from a single point
- FM Radio to listen to one's favourite music
- Steam room to rejuvenate body
- Exhaust fan circulates fresh air
- Foot massage invigorates tired feet
- Glass rack and shampoo box provide storing space
- Soft back rest to sit back and relax

Cat. No. B2513112



CADEO
 Steam Shower Room
 1700 x 850 x 2200 mm

- Ceiling Shower gives rain shower experience
- Hand Shower
- Top and back lamps provide bathroom like ambience
- Back massage jets gently soothe and invigorate body
- Control panel to operate all functions from a single point
- FM Radio to listen to one's favourite music
- Steam room to rejuvenate body
- Exhaust fan circulates fresh air
- Foot massage invigorates tired feet
- Glass rack and shampoo box provide storing space
- Two level glass rack optimises storage
- Soft back rest to sit back and relax
- Pop-up drainer drains water and also works as overflow
- Six body jets to massage the body thereby improving blood circulation

Cat. No. B2513113



CZAR
 Steam Shower Room with Whirlpool
 1500 x 1500 x 2150 mm

- Whirlpool bathtub for two people
- Shower room with steam generator and ventilator
- Six water jets for back and body massage
- Foot massage
- Hand shower and overhead rain shower
- Hot & cold mixer and diverter
- Pleasant mood-elevating lights
- Mirror with shampoo holder and towel rack
- Steam cleaning function
- FM Radio
- Telephone to take calls
- Multi functional electronic panel

Cat. No. B2514102



CUBIT
 Steam Shower Room with Whirlpool
 1300 x 1300 x 2150 mm

- Whirlpool bathtub
- Shower room with steam generator and ventilator
- Six water jets for back and body massage
- Foot massage
- Hand shower and overhead rain shower
- Hot & cold mixer and diverter
- Pleasant mood-elevating lights
- Mirror with shampoo holder and towel rack
- Steam cleaning function
- FM Radio
- Telephone to take calls
- Multi functional electronic panel

Cat. No. B2514103



CAMIKA
 Steam Shower Room
 1500 x 1500 x 2250 mm

- Suitable for two people to enjoy personal moments loved ones
- Ceiling Shower gives rain shower experience
- Hand Shower
- Top and back lamps provide bathroom like ambience
- Back massage jets gently soothe and invigorate body
- Control panel to operate all functions from a single point
- FM Radio to listen to one's favourite music
- Steam room to rejuvenate body
- Exhaust fan circulates fresh air
- Foot massage invigorates tired feet
- Glass rack and shampoo box provide storing space
- Soft back rest to sit back and relax
- Pop-up drainer drains water and also works as overflow
- Mirror
- Six body jets to massage the body thereby improving blood circulation

Cat. No. B2513114

SHOWER CUBICLES



CUBA
Shower Cubicle
900 x 900 x 1950 mm

- Rectangular design
- Corner installation
- Shower cubicle with tray
- Two fixed glass panels with two sliding doors (doors open at corner)

Cat. No. B2511101



COCOON
Shower Cubicle
950 x 950 x 1950 mm

- Curved design
- Corner installation
- Shower cubicle with tray
- Two fixed glass panels with two sliding doors

Cat. No. B2511103



CIGMA
Shower Cubicle
1200 x 900 x 2000 mm

- Rectangular design
- Corner installation
- Shower cubicle with tray
- Two fixed glass panels with one sliding door

Cat. No. B2511104



CABRINI
Shower Cubicle
900 x 900 x 1800 mm

- 5 mm thick glass with painted design
- Sliding door
- Without tray and drainer
- Chrome polished aluminum profile
- Magnetic strip

Cat. No. B2511110

SHOWER PARTITIONS



CADET
Shower Partition

- Available in three custom sizes
- Two Fixed glasses and two Sliding doors

Available sizes
Cat. No. B2510103 1670 x 1920 mm



COLTEN
Shower Partition

- Available in three custom sizes
- Length tolerance upto 3 cms
- Frames made from 5052 aluminum alloy
- Two Fixed glasses and two Sliding doors
- Glass: 6 mm thick, tinted and tempered for safety

Available sizes
Cat. No. B2510107 1650 x 1900 mm
Cat. No. B2510108 1600 x 1900 mm

SHOWER PARTITIONS



CADMEGA NEW
Shower Partition

- One door
- Chrome profile with plastic grey handle
- 6 mm printing glass
- 180 degree swinging glasses
- Adjustment about 1.5 cm each side

Cat. No. B2510117 1000 x 1800 mm

CADMAX
Shower Partition 900 x 1800 mm

- Single door – easy installation
- Chrome profiles Ideal for bathroom conditions
- 180 degree swinging glass allows door to open from both inside and outside
- 1.5 mm tolerance allows installation in un-ideal walls
- Grey plastic handle adds elegance

Cat. No. B2510112

CADMID
Shower Partition 600 x 1800 mm

- Single door – easy installation
- Chrome profiles Ideal for bathroom conditions
- 180 degree swinging glass allows door to open from both inside and outside
- 1.5 mm tolerance allows installation in un-ideal walls
- Grey plastic handle adds elegance

Cat. No. B2510113

CADMIN
Shower Partition 300 x 1800 mm

- Single door – easy installation
- Chrome profiles Ideal for bathroom conditions
- 180 degree swinging glass allows door to open from both inside and outside
- 1.5 mm tolerance allows installation in un-ideal walls
- Grey plastic handle adds elegance

Cat. No. B2510114



CARMAX
Shower Partition 900 x 1950 mm

- 6 mm clear glass folding partition
- Width 900 mm

Cat. No. B2510115

CARMID
Shower Partition 600 x 1950 mm

- 6 mm clear glass folding partition
- Width 600 mm

Cat. No. B2510116

BATH TUBS WITH WHIRLPOOL



COLLEEN
Whirlpool Bathtub
1700 x 900 x 720 mm

- Whirlpool bath tub
- Air and water jets for hydro body massage
- Hand shower
- Hot & cold mixer and diverter

Cat. No. B2524101



CAMERON
Whirlpool Bath Tub with LCD TV
1700 x 780 x 650 mm

- Whirlpool bath tub
- 15" LCD TV with remote control
- Underwater lights for chromotherapy
- Adjustable air and water jets for hydro body massage
- FM Radio
- Touch screen control panel
- 1 HP Pump
- Residual current device for safety, balancing electric current

Cat. No. B2524103

BATH TUBS WITH WHIRLPOOL



CABUSA

Hydro Massage Bath Tub for Two with Whirlpool 1800 x 1200 x 680 mm

- Whirlpool bath tub for two
- Two hydro jets and 8 water jets to massage the body thereby improving blood circulation
- Computer control panel with hot and cold mix controls all functions from a single point
- Hand Shower
- LED light for mood elevation
- Pop-up drainer drains water and also works as overflow

Cat. No. B2524105

CAHIRA

Hydro Massage Bath Tub with Whirlpool 1700 x 800 x 680 mm

- Three hydro jets and 4 water jets to massage the body thereby improving blood circulation
- Computer control panel with hot and cold mix controls all functions from a single point
- Hand Shower
- LED light for mood elevation
- Pop-up drainer drains water and also works as overflow

Cat. No. B2524106



CAITIE

Bath Tub for Two with Whirlpool 1500 x 1500 x 670 mm

- Whirlpool bath tub for two
- Six big jets to massage the body thereby improving blood circulation
- Computer control panel with hot and cold mix controls all functions from a single point
- Hand Shower
- LED light for mood elevation
- Pop-up drainer drains water and also works as overflow

Cat. No. B2524107

CALEN

Bath Tub for Two with Whirlpool 1800 x 1200 x 660 mm

- Whirlpool bath tub for two
- 11 big jets to massage the body thereby improving blood circulation
- Computer control panel with hot and cold mix controls all functions from a single point
- Hand Shower
- LED light for mood elevation
- Pop-up drainer drains water and also works as overflow

Cat. No. B2524108



CERA

BATH TUBS



CAROL

1670 x 760 x 400 mm

Cat. No. B2520101 Carol Bath tub
Cat. No. B2521101 Front panel
1650 x 460 mm
Cat. No. B2521104 Side panel
750 x 460 mm
Cat. No. B2522101
Supporting structure (for one panel)



CERATON

1670 x 760 x 375 mm

Cat. No. B2520102 Ceraton Bath tub
Cat. No. B2521101 Front panel
1650 x 460 mm
Cat. No. B2521104 Side panel
750 x 460 mm
Cat. No. B2522101
Supporting structure (for one panel)



CORNER

1400 x 1400 x 440 mm

• Corner installation
Cat. No. B2520103 Bath tub
Cat. No. B2521102 Corner panel (One piece)
Cat. No. B2522102
Supporting structure



CITADEL

1520 x 760 x 400 mm

Cat. No. B2520104 Bath tub
Cat. No. B2521103 Front panel
Cat. No. B2521105 Side panel
Cat. No. B2522103
Supporting structure (for one panel)



CONY

Cat. No. B2520105
1800 x 920 x 400 mm

Cat. No. B2520106
1800 x 760 x 400 mm

TRAYS

Corner

Cat. No. B2512101

Square

Cat. No. B2512102

SHOWER PANELS



CORAL PREMIUM
200 x 1400 mm

- Shower panel made of 304 Grade, 1-1.2 mm thickness stainless steel
- Brushed stainless steel panel gives smooth finish
- Overhead shower with self cleaning nozzles
- Hand shower with 1.5 metre long hose with stainless steel finish
- Diverter and spout
- Tested at 3 to 5 bar pressure
- Water consumption/discharge 8-10 litres per minute
- Smooth brushed surface is easy to clean hard water deposits

Cat. No. B2530101



CORAL
200 x 1400 mm

- Shower panel made of 5052 grade aluminium alloy body
- Brushed aluminium body surface gives smooth finish
- Overhead shower with self cleaning nozzles
- Hand shower with 1.5 metre long hose with stainless steel finish
- Diverter for shower arrangement and spout
- Tested at 3 to 5 bar pressure
- Water consumption/discharge 8-10 litres per minute
- Smooth brushed surface is easy to clean hard water deposits

Cat. No. B2530102



CYPRUS PREMIUM
200 x 1500 mm

- Shower panel made of aluminium 5052 alloy body
- Overhead shower with rainfall shower arrangement
- 4 jets and hand shower with 1.5 meters long stainless hose
- Tested at 3 to 5 bar pressure
- Thermostatic valve for stable water temperature
- Water consumption/discharge 8-10 litres per minute

Cat. No. B2530104



CHANE
200 x 1350 mm

- Shower panel made of 5052 grade aluminium alloy body
- Brushed aluminium body surface gives smooth finish
- Overhead shower, hand shower and 3 round body massage jets
- Diverter for shower arrangement and spout
- Hand shower with 1.5 metre long hose with stainless steel finish
- Tested at 3 to 5 bar pressure
- Water consumption/discharge 8-10 litres per minute
- Smooth brushed surface is easy to clean hard water deposits

Cat. No. B2530111



CHARIS
200 x 1500 mm

- Shower panel made of 5052 grade aluminium alloy body
- Brushed aluminium body surface gives smooth finish
- Overhead shower, hand shower and 4 square body massage jets
- Diverter for shower arrangement and spout
- Hand shower with 1.5 metre long hose with stainless steel finish
- Tested at 3 to 5 bar pressure
- Water consumption/discharge 8-10 litres per minute
- Smooth brushed surface is easy to clean hard water deposits

Cat. No. B2530114



CHAVA
200 x 1600 mm

- Shower panel made of 5052 grade aluminium alloy body
- Brushed aluminium body surface gives smooth finish
- Overhead shower, hand shower and 5 round body massage jets
- Diverter for shower arrangement and spout
- Hand shower with 1.5 metre long hose with stainless steel finish
- Tested at 3 to 5 bar pressure
- Water consumption/discharge 8-10 litres per minute
- Smooth brushed surface is easy to clean hard water deposits

Cat. No. B2530115



CONRAL PREMIUM
200 x 1500 mm

- Shower panel made of 5052 grade aluminium alloy body
- Brushed aluminium body surface gives smooth finish
- Thermostatic valve for regulating water temperature in:
- Overhead shower, hand shower and 4 body massage jets
- Diverter for shower arrangement and spout
- Hand shower with 1.5 metre long hose with stainless steel finish
- Tested at 3 to 5 bar pressure
- Water consumption/discharge 8-10 litres per minute
- Smooth brushed surface is easy to clean hard water deposits

Cat. No. B2530106



CONWAY
200 x 1500 mm

- Shower panel made of 304 grade stainless steel
- Three jets, rain shower and diverter
- Hand shower with 1.5 meters long stainless steel hose
- Tested at 3 to 5 bar pressure
- Water consumption/discharge 8-10 litres per minute
- Smooth brushed surface is easy to clean hard water deposits

Cat. No. B2530107



CASTOR
200 x 1400 mm

- Shower panel made of 304 grade stainless steel
- Two embedded jets and 400 mm long head shower
- Hand shower with 1.5 meters long stainless steel hose
- Tested at 3 to 5 bar pressure
- Water consumption/discharge 8-10 litres per minute
- Smooth brushed surface is easy to clean hard water deposits

Cat. No. B2530109

PRESSURE PUMPS



CRYPTON LITE

- Pressure Pump**
- Horse Power: 0.5 HP
 - Suction Size (NRV) : 25 mm
 - Discharge Size: 25 mm
 - Tank Capacity: 24 Litres
 - Flow Rate: 3500 lph
- Pressure Pump B2540101
Tank B2541101



CRYPTON SUPER

- Pressure Pump**
- Horse Power: 0.75 HP
 - Suction Size (NRV) : 25 mm
 - Discharge Size: 25 mm
 - Tank Capacity: 24 Litres
 - Flow Rate: 3400 lph
- Pressure Pump B2540102
Tank B2541101

Notes: Due to continuous upgradations, product specifications may change from time to time. Please verify the actual product for correct specifications before purchase. Please see physical product before final selection. Warranty of the product will become null and void if the installation is not done as recommended and/or if not done by qualified technicians. Whilst every precaution has been taken in the compilation of the catalogue, we do not accept responsibility for any error or omission. The designs are subject to change without prior notice. All dimensions are in millimetre (nominal), ±5 mm variations to be considered. TSizes mentioned are approximations only. For exact product size check the actual products.

MIRROR

CERA
Mirrors

Inspired by art and luxury, a range of mirrors reflecting its passion for style. Elegant lines and graceful curves give aesthetically appealing designs.



INDEX

OLD CAT. NO.	NEW CAT. NO.	PRODUCT	PAGE NO.
5549	B3510101	Mirror 800 x 600 mm	188
5550	B3510102	Mirror 800 x 500 mm	188
5551	B3510103	Mirror 800 x 600 mm	188
5552	B3510104	Mirror 800 x 600 mm	188
5553	B3510105	Mirror 800 x 600 mm	188
5555	B3510106	Mirror 700 x 500 mm	188
5556	B3510107	Mirror 700 x 500 mm	188
5557	B3510108	Mirror 700 x 500 mm	188
5558	B3510109	Mirror 700 x 500 mm	188
5559	B3510110	Mirror 700 x 500 mm	189
5560	B3510111	Mirror 700 x 500 mm	189
5561	B3510112	Mirror 700 x 500 mm	189
5562	B3510113	Mirror 700 x 500 mm	189
5563	B3510114	Mirror 700 x 500 mm	189
5564	B3510115	Mirror 700 x 500 mm	189
5565	B3510116	Mirror 450 x 300 mm	189
5566	B3510117	Mirror 600 x 300 mm	189
5567	B3510118	Mirror 600 x 300 mm	189
5568	B3510119	Mirror 600 x 300 mm	190
5569	B3510120	Mirror 450 x 300 mm	190
5570	B3510121	Mirror 450 x 300 mm	190
5512	B3510122	Mirror with Tray 490 x 750 mm	190
5529	B3510123	Engraved Mirror 900 x 500 mm	198
5530	B3510124	Hardware Mirror 600 x 450 mm	190
	B3510131	Framed Mirror 800 x 600 mm	190
	B3510132	Framed Mirror 800 x 600 mm	190
	B3510134	Framed Mirror 800 x 600 mm	190
	B3510136	Framed Mirror 800 x 600 mm	191
	B3510137	Framed Mirror 800 x 600 mm	191
	B3510140	Framed Mirror 800 x 600 mm	191
	B3510141	Framed Mirror 800 x 600 mm	191
	B3510143	Framed Mirror 800 x 600 mm	191
	B3510144	Framed Mirror 800 x 600 mm	191
	B3510146	Shelf Mirror 800 x 600 mm	191
	B3510147	Shelf Mirror 800 x 600 mm	191
	B3510148	Shelf Mirror 800 x 600 mm	191
	B3510149	Shelf Mirror 800 x 600 mm	192
5547	B3520101	Frost-free Mirror 1000 x 1000 mm	192
5548	B3520102	Frost-free Mirror 900 x 700 mm	192
5554	B3520103	Frost-free Mirror 800 x 600 mm	192
5571	B3530101	Led Mirror With Touch Switch 800 x 600 mm	192
5572	B3530102	Led Mirror With Normal Switch 800 x 600 mm	192
5573	B3530103	Led Mirror With Touch Switch 800 x 600 mm	192

OLD CAT. NO.	NEW CAT. NO.	PRODUCT	PAGE NO.
	B3530104	Led Mirror With Touch Switch 800 x 600 mm	192
	B3530105	Led Mirror With Touch Switch 600 x 800 mm	192
	B3530106	Led Mirror With Touch Switch 600 mm dia	193
	B3530107	Led Mirror With Touch Switch 600 mm dia	193
	B3530108	Led Mirror With Touch Switch 800 x 600 mm	193
	B3530109	Led Mirror With Touch Switch 600 mm dia	193
	B3530110	Led Mirror With Touch Switch 600 mm dia	193
	B3530111	Led Mirror With Touch Switch 800 x 600 mm	193
5574	B3510126	Wall Mounted Shaving Mirror	193
5575	B3510127	Table Mounted Shaving Mirror	193
	B3510128	Wall Mounted Shaving LED Mirror	193
	B3510129	Wall Mounted Shaving LED Mirror	193





Cat. No. B3510101

MIRROR
800 x 600 mm
5 mm thick glass mirror with double coat for protection and longevity, 5 mm coloured glass shelf with stainless rails and silver plating on the back for better reflection



Cat. No. B3510102

MIRROR
800 x 500 mm
5 mm thick glass mirror with double coat for protection and longevity, 5 mm clear glass shelf with stainless rails and silver plating on the back for better reflection



Cat. No. B3510103

MIRROR
800 x 600 mm
5 mm thick glass mirror with double coat for protection and longevity, 5 mm clear glass shelf with stainless rails and silver plating on the back for better reflection



Cat. No. B3510110

MIRROR
700 x 500 mm
5 mm thick glass mirror with double coat for protection and longevity, grounded edges for safety and silver plating on the back for better reflection



Cat. No. B3510111

MIRROR
700 x 500 mm
5 mm thick glass mirror with double coat for protection and longevity, grounded edges for safety and silver plating on the back for better reflection



Cat. No. B3510112

MIRROR
700 x 500 mm
5 mm thick glass mirror with double coat for protection and longevity, grounded edges for safety and silver plating on the back for better reflection



Cat. No. B3510104

ROUND MIRROR
800 x 600 mm
5 mm thick glass mirror with double coat for protection and longevity and silver plating on the back for better reflection



Cat. No. B3510105

ROUND MIRROR
800 x 600 mm
5 mm thick glass mirror with double coat for protection and longevity and silver plating on the back for better reflection



Cat. No. B3510106

MIRROR
700 x 500 mm
5 mm thick glass mirror with double coat for protection and longevity, grounded edges for safety and silver plating on the back for better reflection



Cat. No. B3510113

MIRROR
700 x 500 mm
5 mm thick glass mirror with double coat for protection and longevity, grounded edges for safety and silver plating on the back for better reflection



Cat. No. B3510114

MIRROR
700 x 500 mm
5 mm thick glass mirror with double coat for protection and longevity, grounded edges for safety and silver plating on the back for better reflection



Cat. No. B3510115

MIRROR
700 x 500 mm
5 mm thick glass mirror with double coat for protection and longevity, grounded edges for safety and silver plating on the back for better reflection



Cat. No. B3510107

MIRROR
700 x 500 mm
5 mm thick glass mirror with double coat for protection and longevity, grounded edges for safety and silver plating on the back for better reflection



Cat. No. B3510108

MIRROR
700 x 500 mm
5 mm thick glass mirror with double coat for protection and longevity, grounded edges for safety and silver plating on the back for better reflection



Cat. No. B3510109

MIRROR
700 x 500 mm
5 mm thick glass mirror with double coat for protection and longevity, grounded edges for safety and silver plating on the back for better reflection



Cat. No. B3510116

MIRROR
450 x 300 mm
5 mm thick glass mirror with double coat for protection and longevity and silver plating on the back for better reflection

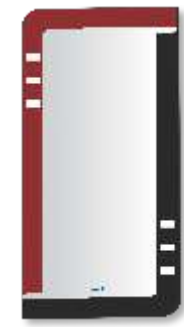

Cat. No. B3510117

MIRROR
600 x 300 mm
5 mm thick glass mirror with double coat for protection and longevity and silver plating on the back for better reflection



Cat. No. B3510118

MIRROR
600 x 300 mm
5 mm thick glass mirror with double coat for protection and longevity and silver plating on the back for better reflection



Cat. No. B3510119

MIRROR
600 x 300 mm
5 mm thick glass mirror with double coat for protection and longevity and silver plating on the back for better reflection



Cat. No. B3510120

MIRROR
450 x 300 mm
5 mm thick glass mirror with double coat for protection and longevity and silver plating on the back for better reflection



Cat. No. B3510121

MIRROR
450 x 300 mm
5 mm thick glass mirror with double coat for protection and longevity and silver plating on the back for better reflection



Cat. No. B3510136

FRAMED MIRROR
800 x 600 mm
5 mm thick glass mirror with double coat for protection and longevity, decorative PU frame and silver plating on the back for better reflection



Cat. No. B3510137

FRAMED MIRROR
800 x 600 mm
5 mm thick glass mirror with double coat for protection and longevity, decorative PU frame and silver plating on the back for better reflection



Cat. No. B3510140

FRAMED MIRROR
800 x 600 mm
5 mm thick glass mirror with double coat for protection and longevity, decorative PU frame and silver plating on the back for better reflection



Cat. No. B3510122

MIRROR WITH TRAY
490 x 750 mm
5 mm thick glass mirror with anti-crack film on the back



Cat. No. B3510123

ENGRAVED MIRROR
500 x 900 mm
5 mm thick glass mirror with anti-crack film on the back



Cat. No. B3510124

HARDWARE MIRROR
600 x 450 mm
5 mm thick glass mirror with anti-crack film on the back



Cat. No. B3510141

FRAMED MIRROR
800 x 600 mm
5 mm thick glass mirror with double coat for protection and longevity, decorative PU frame and silver plating on the back for better reflection



Cat. No. B3510143

FRAMED MIRROR
800 x 600 mm
5 mm thick glass mirror with double coat for protection and longevity, decorative PU frame and silver plating on the back for better reflection



Cat. No. B3510144

SHELF MIRROR
800 x 600 mm
5 mm thick glass mirror with double coat for protection and longevity, 3 shelves with 5 mm clear glass and stainless rails and silver plating on the back for better reflection



Cat. No. B3510131

FRAMED MIRROR
800 x 600 mm
5 mm thick glass mirror with double coat for protection and longevity, decorative PU frame and silver plating on the back for better reflection



Cat. No. B3510132

FRAMED MIRROR
800 x 600 mm
5 mm thick glass mirror with double coat for protection and longevity, decorative PU frame and silver plating on the back for better reflection



Cat. No. B3510134

FRAMED MIRROR
800 x 600 mm
5 mm thick glass mirror with double coat for protection and longevity, decorative PU frame and silver plating on the back for better reflection

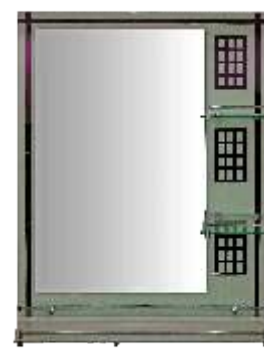

Cat. No. B3510146

SHELF MIRROR
800 x 600 mm
5 mm thick glass mirror with double coat for protection and longevity, 3 shelves with 5 mm clear glass and stainless rails and silver plating on the back for better reflection



Cat. No. B3510147

SHELF MIRROR
800 x 600 mm
5 mm thick glass mirror with double coat for protection and longevity, 2 shelves with 5 mm clear glass and stainless steel rail and silver plating on the back for better reflection



Cat. No. B3510148

SHELF MIRROR
800 x 600 mm
5 mm thick glass mirror with double coat for protection and longevity, 5 mm clear glass shelf with stainless steel rail and silver plating on the back for better reflection



Cat. No. B3510149

SHELF MIRROR
800 x 600 mm

5 mm thick glass mirror with double coat for protection and longevity, 5 mm clear glass shelf with stainless steel rail and silver plating on the back for better reflection



Cat. No. B3520101

MIRROR WITH FROST FREE TECHNOLOGY
1000 x 1000 mm

5 mm thick glass mirror with double coat for protection and longevity and silver plating on the back for better reflection



Cat. No. B3520102

MIRROR WITH FROST FREE TECHNOLOGY
900 x 700 mm

5 mm thick glass mirror with double coat for protection and longevity and silver plating on the back for better reflection



Cat. No. B3530106

LED MIRROR WITH TOUCH SWITCH
600 mm dia

5 mm thick glass mirror with Decorative high bright LED strip with touch switch for LED light, light weight PVC back box, double coat for protection and longevity and silver plating on the back for better reflection



Cat. No. B3530107

LED MIRROR WITH TOUCH SWITCH
600 mm dia

5 mm thick glass mirror with Decorative high bright LED strip with touch switch for LED light, light weight PVC back box, double coat for protection and longevity and silver plating on the back for better reflection



Cat. No. B3530108

LED MIRROR WITH TOUCH SWITCH
800 x 600 mm

5 mm thick glass mirror with Decorative high bright LED strip, Touch switch for LED light, light weight aluminium back box and double coat for protection and longevity and on silver plating the back for better reflection



Cat. No. B3520103

LIGHT MIRROR WITH FROST FREE TECHNOLOGY
800 x 600 mm

5 mm thick glass mirror with double coat for protection and longevity and silver plating on the back for better reflection



Cat. No. B3530101

LED MIRROR WITH TOUCH SWITCH
600 x 800 mm

5 mm thick glass mirror with touch switch for LED light, light weight aluminum back box carrying entire unit, double coat for protection and longevity and silver plating on the back for better reflection



Cat. No. B3530102

LED MIRROR WITH NORMAL SWITCH
600 x 800 mm

5 mm thick glass mirror with normal switch for LED light, light weight aluminum back box carrying entire unit, double coat for protection and longevity and silver plating on the back for better reflection

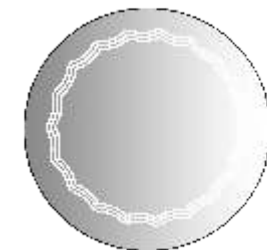

Cat. No. B3530109

LED MIRROR WITH TOUCH SWITCH
600 mm dia

5 mm thick glass mirror with Decorative high bright LED strip with touch switch for LED light, light weight PVC back box, double coat for protection and longevity and silver plating on the back for better reflection

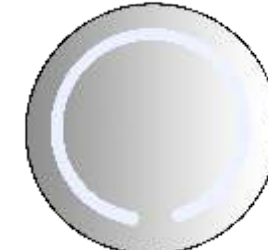

Cat. No. B3530110

LED MIRROR WITH TOUCH SWITCH
600 mm dia

5 mm thick glass mirror with Decorative high bright LED strip with touch switch for LED light, light weight PVC back box, double coat for protection and longevity and silver plating on the back for better reflection



Cat. No. B3530111

LED MIRROR WITH TOUCH SWITCH
800 x 600 mm

5 mm thick glass mirror with Decorative high bright LED strip, Touch switch for LED light, light weight aluminium back box and double coat for protection and longevity and on silver plating the back for better reflection



Cat. No. B3530103

LED MIRROR WITH TOUCH SWITCH
800 x 600 mm

5 mm thick glass mirror with touch switch for LED light, light weight aluminum back box carrying entire unit, double coat for protection and longevity and silver plating on the back for better reflection



Cat. No. B3530104

LED MIRROR WITH TOUCH SWITCH
800 x 600 mm

5 mm thick glass mirror with Decorative high bright LED strip, Touch switch for LED light, double coat for protection and longevity and on silver plating the back for better reflection



Cat. No. B3530105

LED MIRROR WITH TOUCH SWITCH
600 x 800 mm

5 mm thick glass mirror with Decorative high bright LED strip, Touch switch for LED light, double coat for protection and longevity and on silver plating the back for better reflection



Cat. No. B3510126

WALL MOUNTED SHAVING MIRROR
200 mm Dia

Double sided mirror with one side Convex Mirror, 3 mm thick glass, Double coat for protection and longevity



Cat. No. B3510127

TABLE MOUNTED SHAVING MIRROR
200 mm Dia

Double sided mirror with one side Convex Mirror, 3 mm thick glass, Double coat for protection and longevity



Cat. No. B3510128

WALL MOUNTED SHAVING LED MIRROR
220 x 155 mm

Rectangle shape mirror, One sided concave mirror for 3X magnification, Double coat for protection and longevity, Button switch for LED light, 304 SS base and brass body



Cat. No. B3510129

WALL MOUNTED SHAVING LED MIRROR
200 mm dia

Round shape mirror, Double sided mirror with 3X magnification concave mirror on one side, Double coat for protection and longevity, Button switch for LED light, 304 SS base and brass body

Notes: • Due to continuous upgradations, product specifications may change from time to time. Please verify the actual product for correct specifications before purchase. Please see physical product before final selection. • Whilst every precaution is taken in the compilation of our catalogue, we do not accept responsibility for any addition/omission or error. • All dimensions are in millimetre (nominal), ±5 mm variations to be considered.

